

February, 1925

THE JOHN CRERAR  
LIBRARY  
FEB 27 1925

# RADIO IN THE HOME

by HENRY M. NEELY



*In this Issue:*  
GRIMES' FINAL  
3XP



*Resonant Wood  
insures  
Tone Quality*

*“With the  
Tongues of Men”*

HUMAN voices pulsating with life, vibrant with emotion; speak from Music Master rich and clear, as in the church, miles or hundreds of miles away.

In the comfort of your own home—near or far—you hear the sermon, the organ, the singing, the entire church service, as though you were seated among the congregation.

The reproducing element of Music Master responds to the faintest radio impulses; the heavy cast aluminum tone chamber eliminates blast and distortion; the amplifying bell of natural wood—like the violin and the cello—reproduces in tones that are full, resonant and life-like.

Your dealer will be glad to send Music Master to your home to be tried and proved with your own set.

*Dealers Everywhere*

Connect MUSIC MASTER in place of headphones. No batteries.	Model VI, 14-inch	\$30
	Model VII, 21-inch	\$35
No adjustments.	Model VIII, Cabinet Type with "Full-Floating" Wood Horn	\$35

**Music Master Corporation**  
Makers and Distributors of High-Grade Radio Apparatus  
10th and Cherry Streets  
Chicago PHILADELPHIA Pittsburgh

**Music  
Master**  
RADIO REPRODUCER



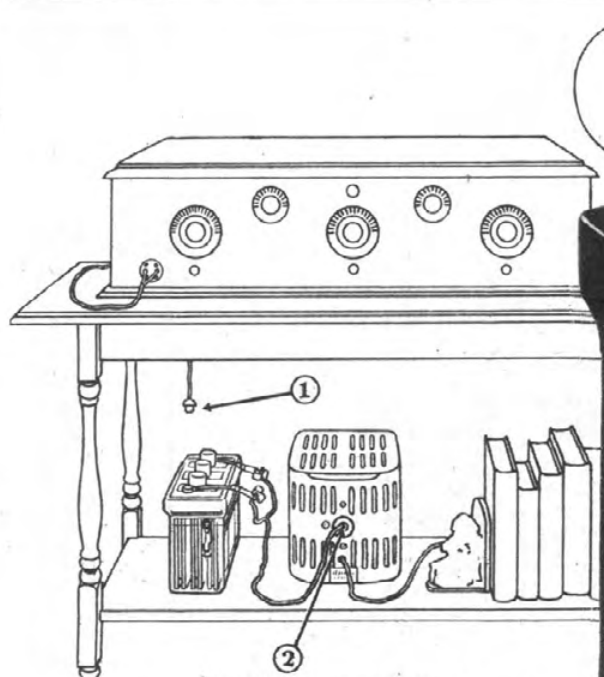

Philco "A" Battery on Charge

To connect battery to receiving set just pull out plug (2) from the Philco NOISELESS Charger and push into receptacle (1).

Philco Double Charger for all "B" batteries and UD86 "A" Batteries. Noiseless. . . . Price \$15

Philco Single Charger for all "B" batteries and UD44 "A" Batteries. Noiseless. . . . Price \$9.75  
Charger Prices include plugs and receptacles.

Built-in Charge Indicator

Balls float when the battery is charged, and sink as the battery becomes discharged.

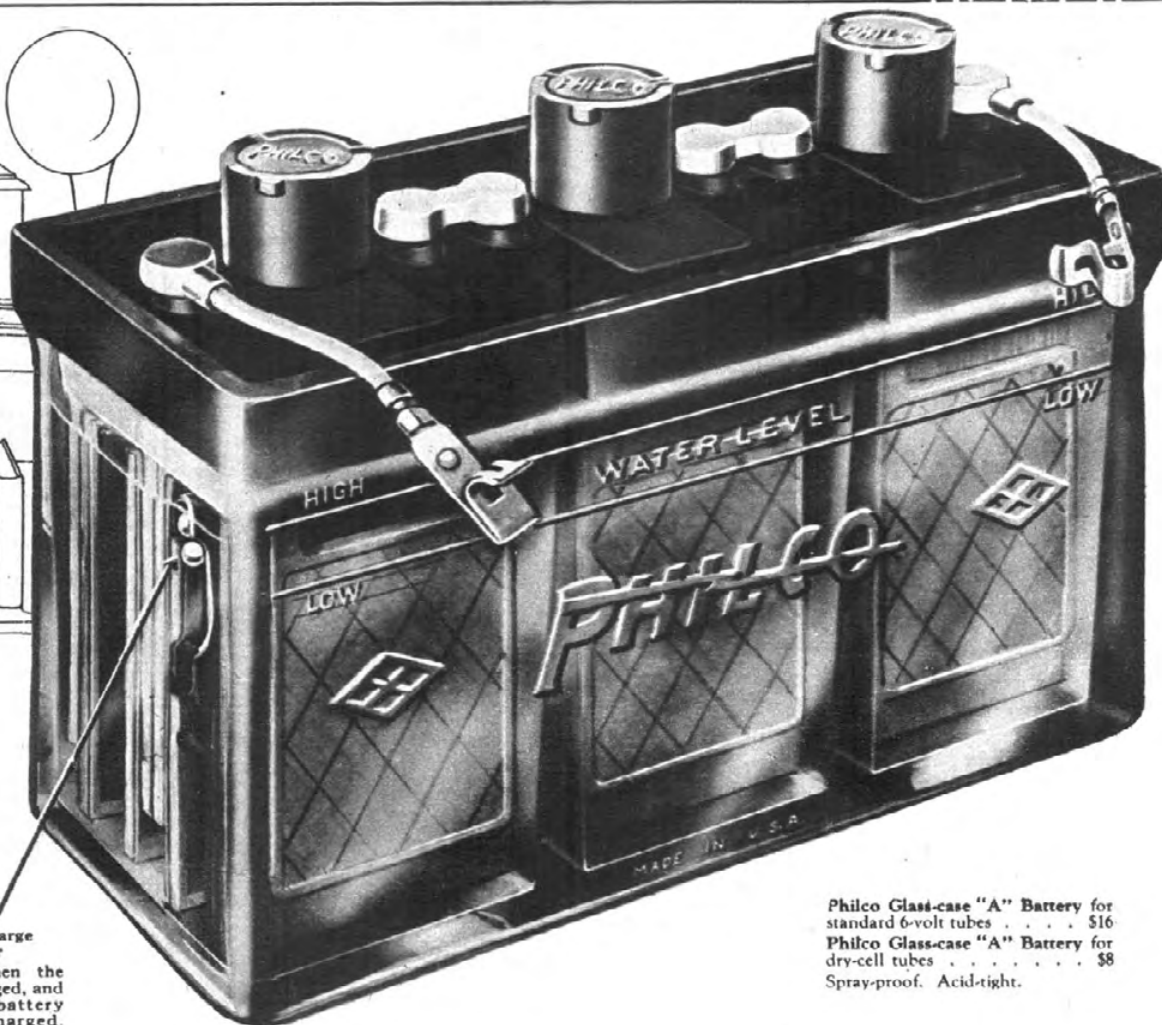

Philco Glass-case "A" Battery for standard 6-volt tubes . . . . \$16  
Philco Glass-case "A" Battery for dry-cell tubes . . . . \$8  
Spray-proof. Acid-tight.



Philco "B" Battery

Storage "B" Batteries are just as essential for clear and distant reception as storage "A" Batteries. Philco "B" Batteries stay clean and dry. Charge without disconnecting a single wire. Use a Philco Charger and "B" Charging Panel (\$2.75).

With de luxe mahogany-finish case with cover (48 volts) . . . . \$20  
With handsome mahogany case without cover (48 volts) . . . . \$16.50



Philco Mahoganyized-Case "A" Batteries

Two types—RAR and RW—for 6-volt tubes. Both in beautiful Adam-brown mahogany-finish cases harmonizing with your radio cabinet. Price . . . . \$14.50 up

Philco Charge Tester—permanently mounted in filler cap, avoids fussing with hydrometer, \$1 extra.

## Recharge in your living room without changing a wire

Recharging a Philco Radio Battery with a Philco NOISELESS Charger means merely pulling a plug from your radio socket and pushing it into the charger socket. No changing wires. No moving the battery. No worry about burning out tubes by getting positive and negative wires mixed.

Philco Radio Batteries—both "A" and "B"—have other big advantages that make storage battery operation easy, convenient, and economical.

They are assembled in attractive acid-tight, spill-proof glass cases—or in wood cases finished in beautiful Adam-brown mahogany. They have exclusive built-in Charge Indicators that tell you at a

glance how far the battery is charged or discharged.

No matter how expensive your radio set—whether it has one tube or many tubes—you must have the steady voltage and strong non-rippling current of a good STORAGE BATTERY for the best result.

Philco Radio Batteries deliver strong non-rippling current *without hum, roar or buzz*. And your Philco is sure to be new and fresh because, of course, Philco Batteries are shipped Dynamic (dry-charged).

See your nearest Philco Service Station, Radio or Music Dealer.

Philadelphia Storage Battery Company, Philadelphia

**MOTOR CAR OWNERS**—avoid the danger and humiliations of battery failure by installing high-powered, long-life Philco Diamond-Grid Batteries. With Philco Retainers, they are **GUARANTEED FOR TWO YEARS**. Philco-made automobile batteries range in exchange price from \$14.95 up.

# PHILCO

## DIAMOND GRID BATTERIES

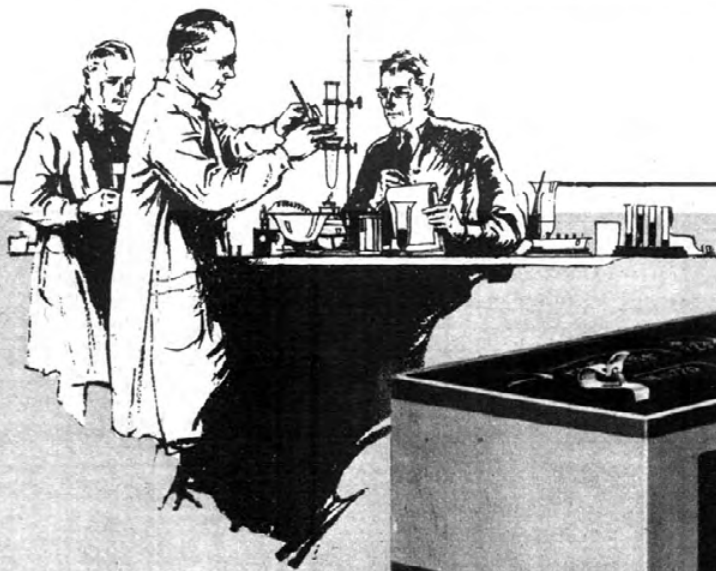

*Dry "B" Batteries  
are an economical,  
dependable and  
convenient source  
of plate  
current!*

No. 770. 45-volt extra large vertical. For heavy duty only. The ideal "B" Battery for use on multi-tube sets. Price \$4.75.

## Scientists constantly improve battery quality

EVEREADY "B" Batteries today contain more electricity, more service, more satisfaction than ever before.

Processes evolved by the scientists of the Union Carbide and Carbon Research Laboratories, Inc., when put in effect in the Eveready factories, are responsible for this great accomplishment.

At the same time the factories have effected a still higher standard of workmanship. A system of inspection that is a marvel of efficiency was inaugurated. The results, gratifying beyond measure, were accomplished with a speed and completeness that have few parallels in industry. The final test showed

more electricity, more battery service, greater Eveready satisfaction without increasing battery sizes and with a substantial reduction in price. "B" Battery operating costs, using the new Evereadys, in most cases show a reduction of at least one-half.

There is an Eveready Radio Battery for every radio use.

Insist on Eveready "B" Batteries.

*Manufactured and guaranteed by*

**NATIONAL CARBON COMPANY, INC.**

*Headquarters for Radio Battery Information*

New York

San Francisco

*Canadian National Carbon Co., Limited, Toronto, Ontario*

EVEREADY HOUR  
EVERY TUESDAY at 9 P. M.  
(Eastern Standard Time)

For real radio enjoyment, tune in the "Eveready Group." Broadcast through stations

WEAF	New York
WJAR	Providence
WEI	Boston
WFI	Philadelphia
WCAP	Pittsburgh
WGR	Buffalo

# EVEREADY Radio Batteries

*- they last longer*

# RADIO IN THE HOME

Vol. III

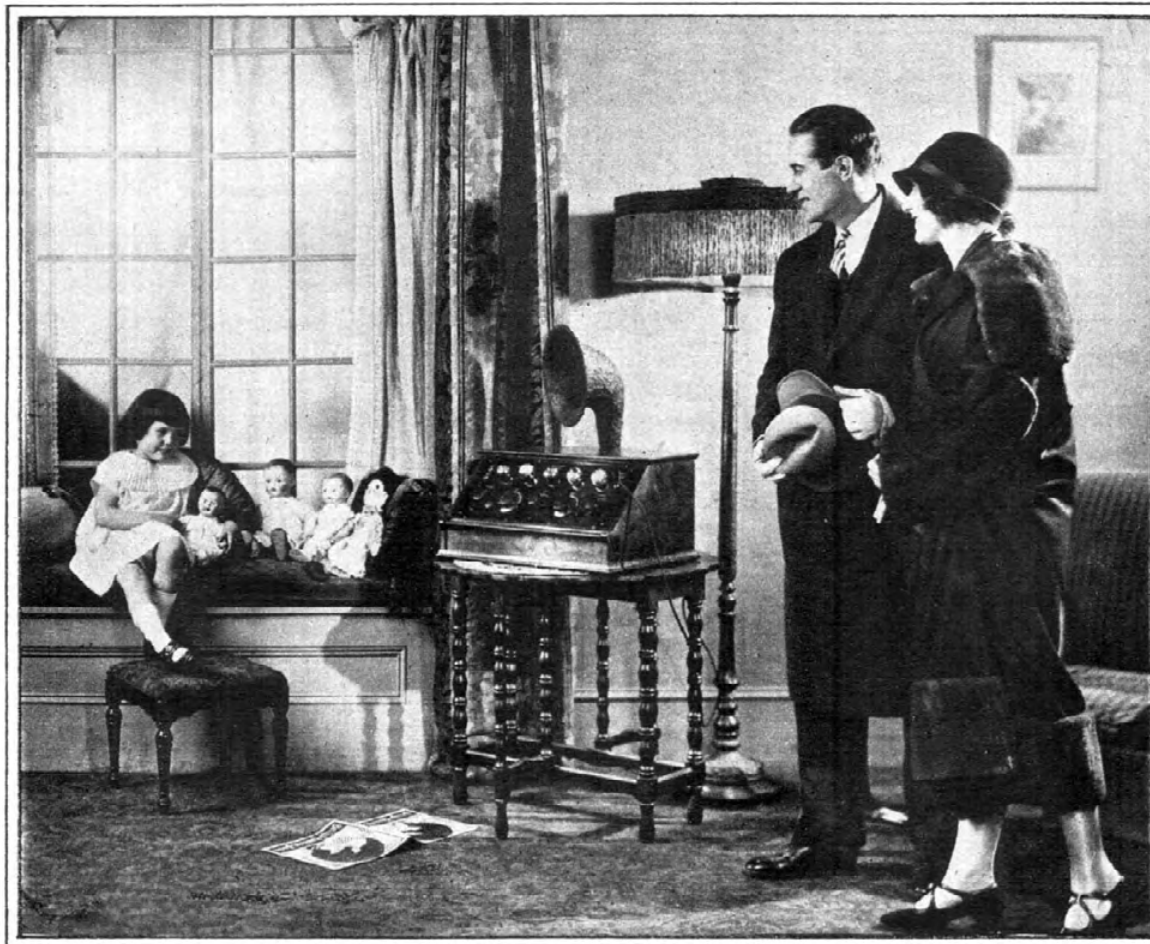

No. IX

*Radio in the Home of Charles H. Dowd, Brooklyn, N. Y. Photo through the courtesy of the Colin B. Kennedy Corp.*

## CONTENTS FOR FEBRUARY, 1925

	Page		Page
Cover Design . . . . . <i>By Arthur Henderson</i>		Reception With the Flewelling Circuit, <i>E. T. Flewelling</i>	24
Editorially Speaking . . . . . <i>Henry M. Neely</i>	6	Can You Explain Radio to Your Friends? <i>Brainard Foote</i>	26
The I-D-P Sure Perks . . . . .	6	KLZ Is a Real Radio in the Home, <i>Vera Brady Shipman</i>	29
Grimes' Final 3XP . . . . .	8	Radio Brings Poetry to Home of Poetess . . . . .	34
The Amazing Story of a Radio Ray, <i>Carl Pfanstiehl</i>	11	For the Inverse Duplex Experimenter, <i>John DeQ. Briggs</i>	42
Grimes' Final 3XP . . . . . <i>David Grimes</i>	12	For the Advanced Student . . . . .	45
Twelve Hundred Kids on the Air . . . . . <i>Jack Nelson</i>	16	Just Write Jean Sargent . . . . . <i>G. P. Allen</i>	53
Harkness Answers Questions on His Reflex and Counterflex Circuits . . . . . <i>Kenneth Harkness</i>	19	Before the "Mike" . . . . . <i>Fred J. Turner</i>	56
Polishing the Door Plate . . . . . <i>Golda M. Goldman</i>	21		

## RADIO IN THE HOME

Published Monthly by the Henry M. Neely Publishing Company, 608 Chestnut St., Philadelphia, Pa.  
Bell Telephone—Lombard 8431  
Experimental Station (3XP), Delanco, N. J.

HENRY M. NEELY.....President and Editor	NORMAN NEELY.....Art Director	BRAINARD FOOTE.....} ..Contributing Editors
G. W. KRAFT.....Secretary and Treasurer	DAVID GRIMES.....} ..Associate Editors	W. FRANCIS GOODREAU.....} ..Laboratory Assistant
W. L. DUDLEY.....General Manager	EDMUND T. FLEWELLING.....} ..Associate Editors	MERRILL NEELY.....} ..Laboratory Assistant
B. M. MORRIS.....Advertising Manager	KENNETH HARKNESS.....} ..Associate Editors	

New England Representative, G. P. ALLEN, 80 Windsor Street, Arlington, Mass. Phone, Arlington, 2533 J

*Radio in the Home* is sold at 10c per copy at all newsstands, radio shops and bookstores. Subscription rates in the United States, \$1.00; Canada, \$1.50; Foreign, \$2.00 per year.

Printed on the rotogravure presses of the Public Ledger, Philadelphia, Pa. Copyright, 1924, by the Henry M. Neely Publishing Company  
Entered as second-class matter May 26th, 1922, at the Postoffice, Philadelphia, Pennsylvania, under the act of March 3, 1879

# EDITORIALLY SPEAKING

By Henry M. Neely

## Is the "Low-Loss" Craze "Bunk?"

IN ALL of the very wide-spread and the very fine tendency today to make every single piece of radio apparatus just as good and just as efficient as it is possible to be, there is only one manufacturer who is carrying on a lone campaign to stop this march of progress.

In virtually all of the radio magazines, except this one, you will see a full-page advertisement with great letters at the top saying: "Are you fooled by low-loss BUNK!"

The word *bunk* is spelled in letters about an inch and a half high with a huge exclamation point after it and the whole thing is in such black type that it jumps right out of the page and hits you.

This manufacturer, who makes variable condensers, goes on to claim that his condensers are "honest." Now, I am perfectly willing to admit that they are honest, but I think it very wise to point out right here that his campaign against the low-loss movement is decidedly misguided and is probably founded upon an insufficient knowledge of just exactly what is expected of a variable condenser and what it actually does under genuine working conditions.

Let us consider two variable condensers, virtually alike in every respect except that condenser A has a good deal of molded material around it while condenser B is virtually all metal and has only sufficient molding material to hold the metal parts rigid and firm.

Let us take these two condensers into the laboratory and test them.

At the very start, we will assume that a perfect condenser would be 100 per cent efficient. We will now test condenser A with its molded end plates and we will find, let us say, that it measures up 90 per cent efficient.

Now let us put condenser B under exactly the same test. It is a fair assumption to say that this condenser also will probably measure up 90 per cent efficient. This seems to

bear out the term "bunk" which this manufacturer uses about this low-loss idea.

These two condensers have proved under laboratory tests that there are losses in both of them somewhere. Now there are two principal forms of losses in a condenser. One is known as dielectric losses and refers to the absorption

of energy by the various materials surrounding the plates of the condenser. Another loss is known as "eddy current" loss, which means that a large amount of metal around the shield of the condenser may set up currents in this metal and absorb energy.

After the test which we have just spoken about, we see that, as an approximation, the dielectric losses of the molded end condenser just about equal the eddy current losses of the all-metal condenser.

Why, then, should everybody be making such a fuss about the "low loss" of the metal condenser?

Well, the test that we have just made has been made in the laboratory where the condenser was placed absolutely by itself and had nothing to do with anything else around it. But condensers are not made and sold to be used in this way. They are made and sold to be used in radio sets and, in the majority of cases today, in the radio frequency circuits of radio

sets. Now let us take a regular five-tube radio frequency circuit and try our condensers in this.

If it were possible to make an exact measurement of the strength of the signals which come in on our antenna and an exact measurement of the strength of the signals which are delivered to the detector tube, it would be very interesting to perform this experiment. It is, as a matter of fact, possible to get an approximation of these two energies through other methods, but the generally used instrument is the human ear.

The physicist in his laboratory has developed extremely delicate instruments by means of which we can explore the

### That "I-D-P" Sure Perks

THE mass of letters which we have received about the Inverse-Duplex Pfanstiehl circuit seem to divide themselves about evenly between astonishing success and discouraging failure. The failures, of course, accuse us of publishing a circuit that is no good. Just to prove what really can be done with this set when it is properly put together, we are publishing here a typical letter:

Dear Mr. Neely:

As a result of going over your "Inverse-Duplex Pfanstiehl" hook-up with a customer of ours, I got all "Grimes-ed" up myself, and decided to try the hook-up.

So two days ago I gathered up the necessary parts, took them home, and proceeded to throw them together. "Throw them" is the correct expression. The panel is a piece of 3-16 in. wood from an apple box and the wiring is done with bell wire. I ran the wires any way to there, being particular about one thing only—that the joints were well and truly soldered.

When I had completed the job even my wife was aghast. "Surely you don't think that will ever work," she said. "Mais oui," said I, "for Mr. Neely says so." "But," she said, "he never expected any one would put a set together like that." I don't suppose you ever did, Mr. Neely; but I wanted to give the hook-up about as difficult a trial as I could.

I had an old loop of very ancient vintage at home. As we are so far from any broadcasting stations here I didn't look for loop reception. Pardon me, we are only about 150 miles from KFOA, at Seattle, but as far as reception goes we might as well be 2000 miles away.

(Continued on Page 58)

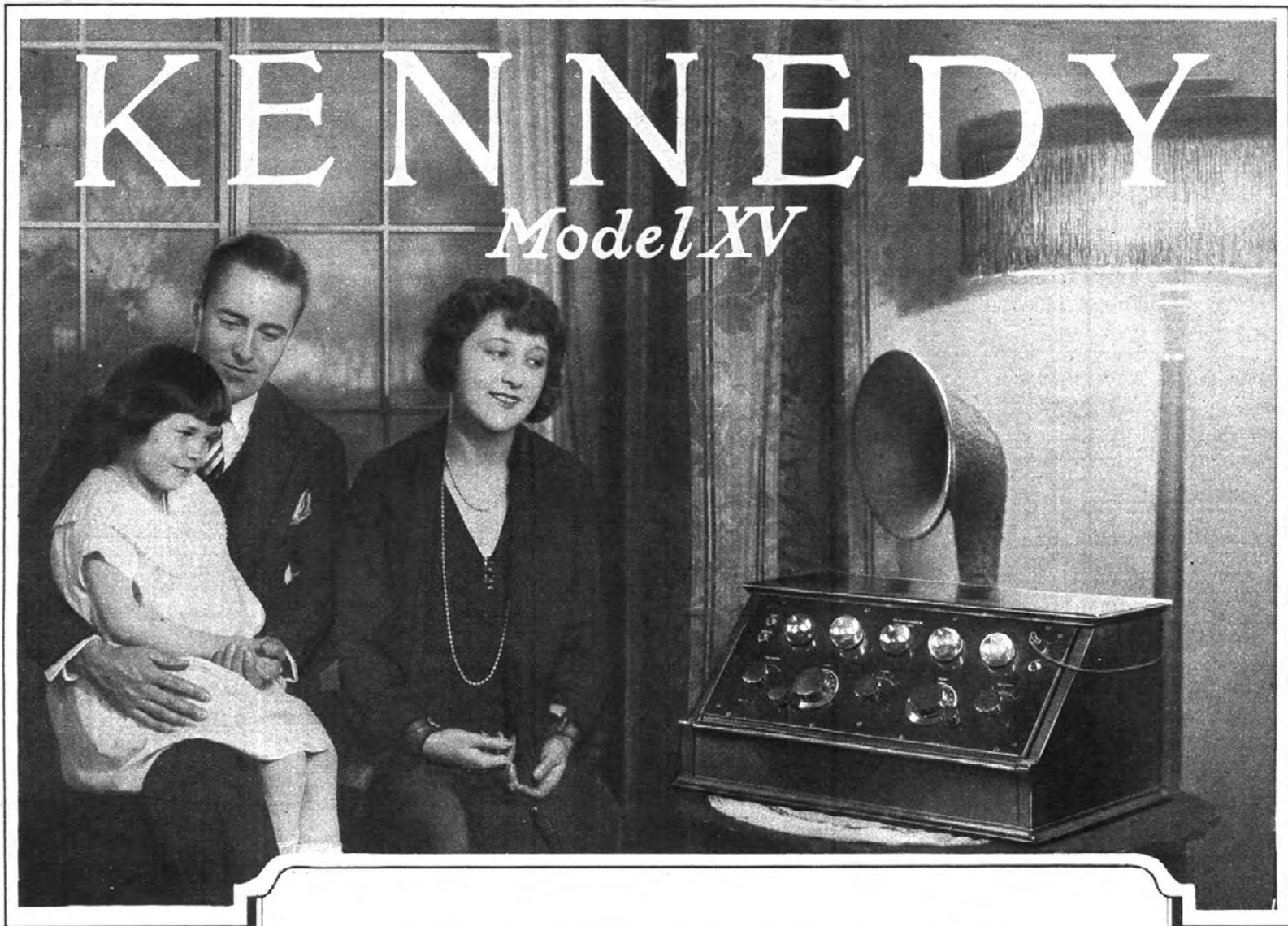

# KENNEDY

## Model XV

### *Four advanced features make this the most satisfying receiver you can buy*

#### SELECTIVITY

Model XV is so superselective that you can cut right through powerful local broadcasting and receive distant stations clearly. Not merely faint, fuzzy whispers, but firm, distinct reception without a trace of interference. In cities like Chicago, where conflicting stations make a broad tuning receiver useless, Model XV separates them completely so any local program can be chosen or all locals can be cut out and long range reception enjoyed. Users tell us they have logged over 150 stations from coast to coast and even across the seas.

#### PURITY OF TONE

Kennedy receivers have always been noted for their fine tone quality. No other receiver of any type approaches the Kennedy in

its brilliant reproduction of every shading of music and inflection of the voice.

#### SIMPLICITY OF TUNING

Each station is always found at its own dial setting. There are only two tuning dials—one for each hand and none left over. Only one figure need be jotted down as the setting for any station. Both dial settings are practically alike. You can set the dials and name the station!

#### VOLUME ON DISTANT PROGRAMS

Stations hundreds of miles away come in so perfectly, with loudspeaker volume, that your friends believe they must be local stations—until they hear the station call letters. You must *hear* this receiver to appreciate its wonderful superiority.

*Write for the address of a dealer who will demonstrate*

THE COLIN B. KENNEDY COMPANY, Saint Louis

The Royalty



of Radio

invisible electro-magnetic and electro-static fields in a radio set. He can place on the table in front of the set a piece of squared paper, draw his instruments to exact scale, explore the various fields inside of the set and draw curves showing exactly how those fields would look if they suddenly became visible to the human eye.

It has been found that as many losses occur through the distortion and clashing of electro-magnetic and electro-static fields about various instruments in a set as occur in the pieces of apparatus themselves. Another very great drawback of distorted fields of this kind is that they tend to set up more radio-frequency self-oscillations than the capacity inside of the tube, upon which most of these oscillations have heretofore been blamed. Consequently, we know from this that any instrument which tends to distort these fields will not only rob the signal of some of its energy but will also start oscillations which require some methods of control such as neutralization or potentiometer, and both of these methods suppress a great deal of energy in order to stop the undesired attributes. In other words, such methods produce losses in themselves.

Let us take the experience of one man in the matter of these condensers.

When Carl Pfanstiehl started out to make a set which would be absolutely free from all radio-frequency self-oscillation, he did not know whether there was any difference between the molded end condenser and the metal end condenser. The molded end condenser was about the only thing on the market at a reasonable price at that time and, of course, with all manufacturers, reasonable price must be a consideration. In other words, the consumer will not pay the high figure necessary if we attempt to build a set out of laboratory instruments. Mr. Pfanstiehl put his molded end condensers in his set and began to work with it. He soon found that he was getting too

much radio-frequency self-oscillation to be controlled without established further losses in order to suppress it. He did not want to establish losses. The radio signal which comes in on our antenna is weak

enough at best and to put losses in its path to our loud speaker is to waste valuable energy. So Mr. Pfanstiehl decided that he must find some way of so arranging his instruments that these radio-frequency self-oscillations would not occur and therefore would not have to be damped out. He took the instruments of the physicist, laid out

circuits, will distort these fields to such an extent as to cause bad self-oscillation or else to establish very decided and important losses of energy. Proof of this lies in the fact that the set which Mr. Pfanstiehl produced has passed a test in our laboratory at Station 3XP which no other set on the market has ever passed. We use at 3XP

what is known as a "heterodyning" wave meter. With this instrument we send out a continuous wave which is at radio frequencies and therefore not audible. In order to make it audible there must be another wave in a receiving set with which this wave meter can form a beat note of such frequency that it can be heard by the human ear.

When there is a broadcasting carrier wave on, this is very easy with any set, because that broadcasting carrier wave gives us the wave we need to heterodyne with. So with virtually every other set, whether there is a broadcasting station or not, when the circuits are in absolute resonance there is sufficient self-oscillation inside of the set to enable us to heterodyne with this wave meter and so get an audible note.

With the Pfanstiehl Model 7 receiver we have never been able to heterodyne unless there was a broadcasting carrier wave coming in through the set. In other words, our attempts to put the circuits in resonance and then heterodyne with our wave meter

have been absolute failures because, even though all of the circuits have been in resonance, there are no self-oscillations set up inside the set, and so there is nothing to heterodyne. This has been done by means of the modern low-loss condenser. It could not possibly be done by means of the molded end condenser.

So please do not be fooled by the full-page advertising of this manufacturer, and his big type slogan—"Are you fooled by low-loss bunk?"

*Low loss is not bunk.* Low loss is the best movement that has hit the radio industry in a long while. It is daily making our receiving sets infinitely better. The modern low-loss condenser is now very nearly 100 per cent efficient. At least it is so nearly 100 per cent efficient that further efficiency seems im-

(Continued on Page 49)

## Grimes' Final 3XP

**I**N THIS issue, David Grimes brings into one complete article and hook-up the various improvements which he has made since last June in his famous Inverse Duplex 3XP receiver.

These improvements with the diagrams given here are founded upon his first 3XP hook-up using honeycomb coils and .0005 condensers. Since then, in inverse duplexing the neutrodyne circuit and the Pfanstiehl system, we have used other coils with .0003 variable condensers and I am quite sure that a number of readers who have built these last two circuits will want to know whether they can adopt the improvements given in this issue.

This can be done, but care must be taken with the coil and condenser attached to the middle dial. It will be noted that in this particular circuit Mr. Grimes has moved the audio-frequency transformer up to the lead from the high end of the secondary to the grid of the tube. Heretofore it has been placed between the lower end of the secondary and the filament connection. Moving it up in this way virtually places an extra condenser across the tuning condenser and therefore will change the logging of this middle dial to such an extent that, with the regular size neutroformer or Pfanstiehl coil, it will be impossible to get the lower wave length stations. In order to do this, you will have to remove a few turns from your neutroformer secondary or the secondary of your Pfanstiehl coils and substitute a .0005 variable condenser for the one you have in order to get the higher wave lengths.

Personally, I think I should leave the transformer

(Continued on Page 57)

his squared paper in the method which I have mentioned and began to explore his fields and transfer their outlines to the paper. He soon found that all around these molded condensers the fields were badly distorted and were distorted in such a way that there was only one conclusion, and that was that *something in that condenser was causing these self-oscillations.*

In trying out other sets, he used three condensers with the metal and plates, and built according to our present loss idea. At once he found that the problem was solved. There were no radio-frequency self-oscillations in the set. These condensers acted just as his theory had told him the set would act and there were no distorted fields.

Once more he laid out his squared paper and drew the outlines of the various fields. There was no distortion. Consequently there was no self-oscillation.

Further experiments have amply proved what Mr. Pfanstiehl discovered. Every condenser with molded end plates, when introduced into the fields of radio-frequency

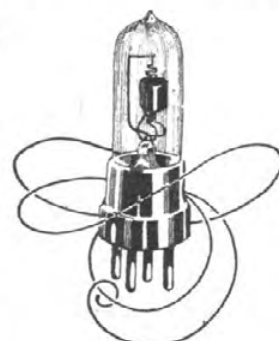
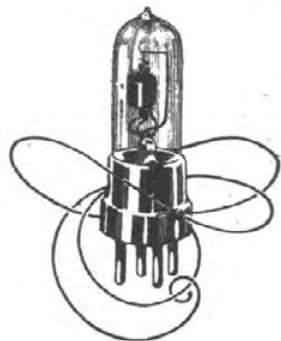



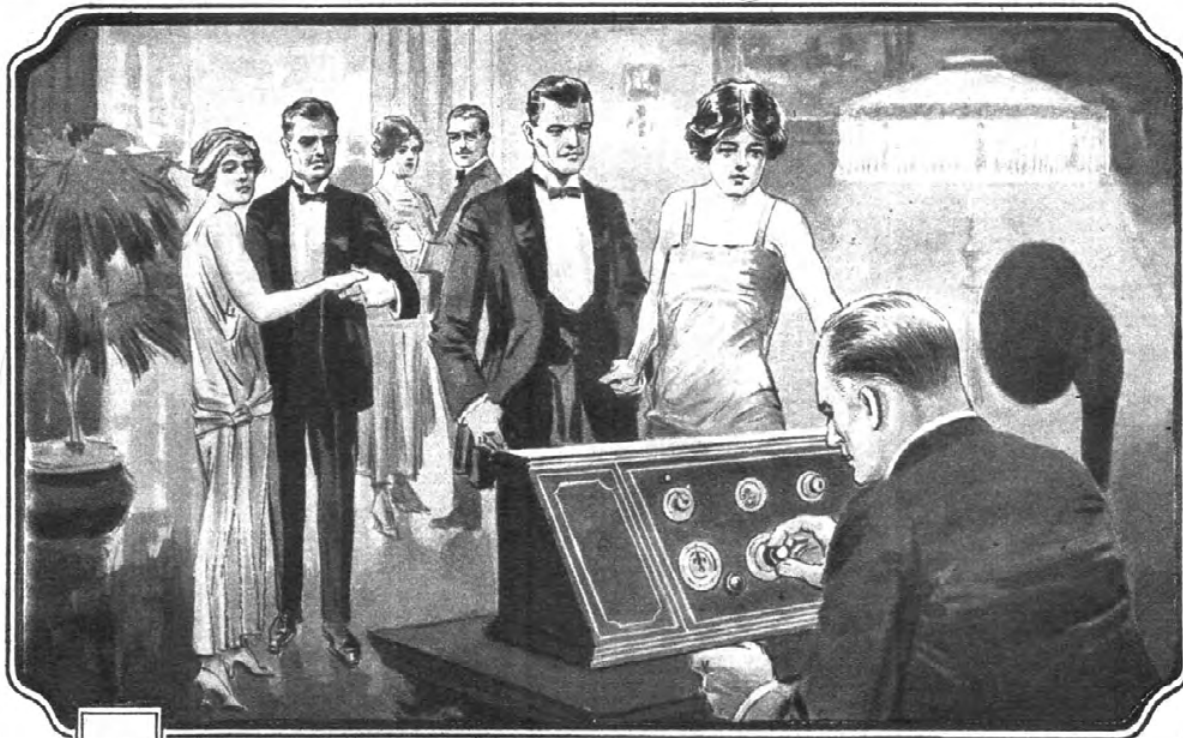

*Are you ready to TUNE IN?*  
**that DISTANT STATION?**

**N**OTHING is more discouraging to a radio fan than to find his batteries down—too weak for good reception.

A weak battery is a noisy battery and, further, current flow is irregular—the reception comes and goes.

A great many pleasant evenings have been spoiled by weak batteries. Hours have been wasted tinkering—when a weak battery was the cause of all the trouble.

The Westinghouse Rectigon Battery Charger is the friend of every radio fan. It will charge your battery over night.

The Rectigon will enhance many fold the pleasures of radio reception. It can be obtained at a small cost.

Make a Rectigon a part of your equipment and forget battery troubles.

See our nearest dealer.

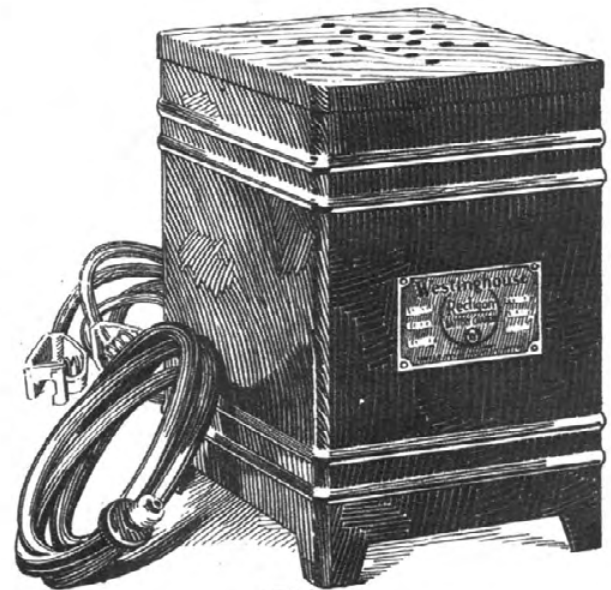

Westinghouse Electric & Manufacturing Company  
 South Bend Works      South Bend, Indiana  
 Sales Offices in All Principal Cities of  
 the United States and Foreign Countries



# Westinghouse

X78471C

# ZENITH RADIO

TRADE MARK REG.



Super-Zenith VII—  
the ideal radio set  
for the fine home

**They Cost More  
But They Do More**

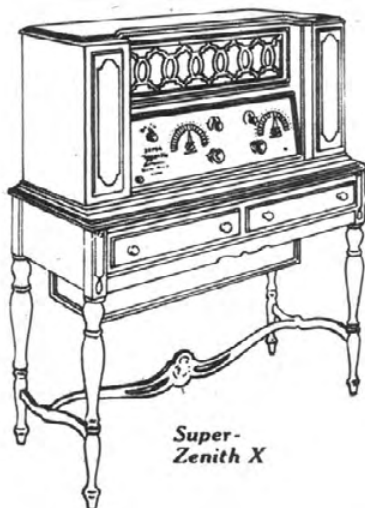

Super-Zenith X

## It's a Proud Home That Owns a Zenith

The new Super-Zenith is beautiful to look at—lends an atmosphere of dignity and worth to library or drawing room.

Naturally you expect unusual performance from so beautiful a radio set. And—unusual performance is *exactly* what you get.

Tuning, for example, is controlled by *two dials only*—so perfectly adjusted that each station comes in always at the same dial settings. *It never varies.* Powerful locals may be on full blast, yet you can tune them out completely and bring in distant stations. Tone reproduction is always clear and true; the volume always adequate.

Before you make your choice, be sure to see and try the new Super-Zenith. A fifteen-minute test will give you a new standard of radio values, as applied to beauty of construction—and—*performance.*

Dealers and Jobbers: Write or wire for our exclusive territorial franchise

### ZENITH RADIO CORPORATION

Dept. R-2 332 South Michigan Avenue, Chicago

ZENITH—the exclusive choice of MacMillan for his North Pole Expedition  
Holder of the Berengaria Record

The complete Zenith line includes seven models, ranging in price from \$95 to \$550.

With either Zenith 3R or Zenith 4R, satisfactory reception over distances of 2,000 to 3,000 miles is readily accomplished, *using any ordinary loud speaker.* Models 3R and 4R licensed under Armstrong U. S. Pat. No. 1,113,149.

The 3R and 4R are NON-RADIATING receivers.

The new Super-Zenith is a six-tube set with a new, unique, and really different patented circuit, controlled exclusively by the Zenith Radio Corporation. It is NOT regenerative.

**SUPER-ZENITH VII**—Six tubes—2 stages tuned frequency amplification—detector and 3 stages audio frequency amplification. Installed in a beautifully finished cabinet of solid mahogany—44 $\frac{1}{2}$  inches long, 16 $\frac{1}{2}$  inches wide, 10 $\frac{1}{2}$  inches high. Compartments at either end for dry batteries. Price (exclusive of tubes and batteries) . . . . . **\$230**

**SUPER-ZENITH VIII**—Same as VII except—console type. Price (exclusive of tubes and batteries) . . . . . **\$250**

**SUPER-ZENITH IX**—Console model with additional compartments containing built-in Zenith loud speaker and generous storage battery space. Price (exclusive of tubes and batteries) . . . . . **\$350**

**SUPER-ZENITH X**—Contains two new features superseding all receivers. 1st—Built in, patented, Super-Zenith Duo-Loud Speakers, (*harmonically synchronized*

*twin speakers and horns*), designed to reproduce both high and low pitch tones otherwise impossible with single-unit speakers. 2nd—Zenith Battery Eliminator, *distinctly a Zenith achievement.* Requires no A or B batteries. Price (exclusive of tubes) . . . . . **\$550**  
Price (without battery eliminator) . . . . . **\$450**

All Prices F. O. B. Factory.

ZENITH RADIO CORPORATION  
Dept. R-2  
332 South Michigan Avenue, Chicago, Ill.

Gentlemen: Please send me illustrated literature giving full details of the Super-Zenith.

Name

Address

# RADIO IN THE HOME

Grimes-Flewelling-Harkness

Associate Editors, Writing for No Other Magazine

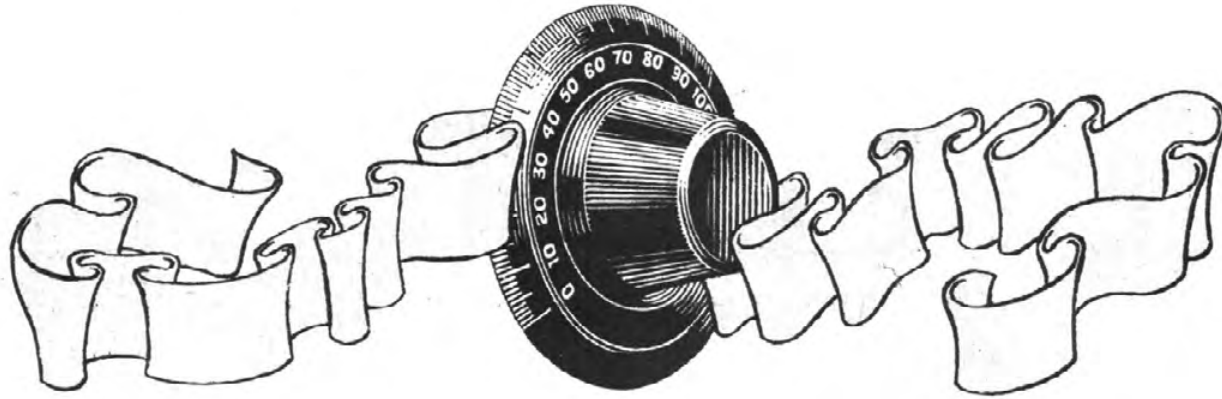

## The Amazing Story of a Radio Ray

RADIO has gripped the public mind more than any other scientific invention has ever done; and this is not to be wondered at when you stop to consider what miracles radio is performing today. It is not only possible, but has been demonstrated entirely practical, to hurl into space and scatter literally to the four corners of the earth, something exactly representing the spoken words of the human voice, the inspiring music of a great orchestra, or even the greatly magnified sound produced by the footsteps of a common fly; and anywhere, thousands of miles away, on land or sea, or in the air above, to pick out of the atmosphere a tiny bit of this "something" and from it reconstruct the sounds as perfectly as they were originally produced.

Just what is it that is shouted out from the broadcasting antenna at the prodigious speed of 186,000 miles per second and picked up at the same instant by thousands of radio receivers everywhere?

This is the most fundamental and important question now facing physicists and scientific experimenters. A complete answer, when it comes, will undoubtedly point the way to a practical solution of such problems as the direct transmission of vision.

Let me say at the outset that a definite and positive answer is not available today, but perhaps it will come tomorrow. There is, however, a growing wealth of exact knowledge fundamental in character and proven by beautiful and precise experiments that is leading rapidly to a definite solution. The new physics had its origin a few years ago when that great woman scientist, Madame Curie, through her infinite patience and skill in discovering and isolating the rare element, radium, forged the key which has unlocked the door to the interior of an atom of matter, and thereby revealed to

By CARL PFANSTIEHL

President Pfanstiehl Radio Company

*THIS is the simplest and at the same time most amazing popular picture of the unbelievable things that are going on in radio that I have yet seen in print.*

*It is a transcript of an address delivered by Mr. Pfanstiehl in the lecture hall of the Coliseum at Chicago recently.*

*The address was broadcast by one of the Chicago stations; but I thought it was well worth while putting in printed form in this way.*

H. M. N.

the mind's eye nature's original workshop where heat and light are manufactured; where energy and matter have their common origin, where electricity is seen to possess a granular structure, and even time itself apparently comes into being. In the few minutes at my disposal I can only mention a few of the most significant

*"The actual amount of energy picked up by a receiving antenna is extremely small. It has been estimated that the amount of energy picked up by an average receiving antenna coming from a broadcasting station 2000 miles away, if made continuous day and night for thirty years, will about equal the energy expended by a common housefly in climbing up a wall a distance of one inch."*

facts leading to the present conception of what a "radio wave" really is.

Many of you will remember when you studied physics a few years ago, you were taught that there were some eighty-six different kinds of atoms or elements from which all of the material universe was constructed. You also remember that several

atoms combine together and form a large unit called a molecule, and the countless number of combinations possible explains the many different kinds of material in existence.

Molecules are extremely small, so small in fact, that if all the molecules of air contained in a thimble should be converted into oranges, the fruit would be sufficient to cover the entire United States with a layer 1000 feet deep. And still the empty space between the molecules of air is thousands of times greater than the space actually occupied by these little bodies themselves! A molecule, however, is a relatively huge affair compared to the size of an atom.

Until the discovery of radium atoms were considered to be indivisible units of matter, but they are now known to be very complicated structures consisting of a central nucleus or "sun," around which constantly revolve in regular orbits one or more tiny particles or "planets" in a manner similar to our solar system. These little bodies revolving around the nucleus are called planetary electrons, while the nucleus contains one or more heavier particles called protons. The simplest of all

the atoms is that of hydrogen, which consists of a nucleus composed of one proton around which revolves one electron. The next simplest atom is that of helium which has a nucleus consisting of four protons and two electrons packed closely together, around which revolve two planetary elec-

trons. When a third planetary electron is added to the system and the nucleus made more complex, we have an atom of lithium. In like manner the atoms of all the different elements are formed simply by the addition in each case of one planetary electron and a corresponding building up of the nucleus. The (Continued on Page 54)

# Grimes Final 3XP

**T**HE changes shown in this "final 3XP" may also be applied to the Grimes-ed Neutrodyne and Pfanstiehl. Read my editorial on Page 8.

Mr. Grimes is now devoting his entire time to laboratory work for the specific purpose of continually improving his inverse duplex system. This, he feels he can do, in view of the protection given him by the issuing of his United States patents. He now has full patent protection in Canada, Great Britain and the United States.

Mr. Grimes will continue to reveal to the readers of "Radio in the Home" his new developments as fast as they are conceived, but it must be understood that these improvements are all being protected by pending patents. Permission is given to the readers to use these circuits for experimental use, but only by license agreement with Mr. Grimes and his associates can they be used for commercial work. Such use without authority would constitute infringement.

H. M. N.

**I**T IS quite natural that every new circuit that comes along should sooner or later find itself Inverse-Duplexed. This prediction was made some months ago and certainly subsequent results have only substantiated the inevitable.

First, Inverse Duplex was applied to the popular fixed radio transformer receivers and here won its name and present standing. Then, as the radio art progressed, it became increasingly evident that greater selectivity was necessary to work through the many stations springing up in every section of the country. Fixed radio transformers were no longer desirable; so Inverse Duplex was combined with tuned radio frequency.

At this time it became apparent to the amateur broadcast experimenter that Inverse Duplex was a system of amplification and was in no sense just another radio circuit. Scene Two then opened up with the article in the January, 1924, issue of "Radio in the Home." This article was called "Grimes Two-Control System" and immediately met a wide need for selectivity.

By **DAVID GRIMES**  
Associate Editor of "Radio in the Home"

### New Features in the Final Grimes 3XP

1. Hard-tube detector.
2. No detector grid leak and condenser.
3. No detector "B" battery.
4. Interchanged audio-radio circuit in first audio tube for eliminating hand capacity on middle dial.
5. Switch for cutting out one audio stage where excessive amplification is not needed.

As the result of many hundreds of experiments of our own and goodness knows how many among the readers, the system was gradually and continually improved leading up to Scene Three. This was the incorporation of tuned radio clear through the entire circuit giving a three control set, similar in tuning to many popular multi-

radio, a tuned crystal detector, and three audio stages. Inquiry by many readers for a detector tube to replace the crystal and for a good loop set led to the Inverse Duplex Neutrodyne and Pfanstiehl. These were the most successful circuits we have yet published. They appeared in the September and November, 1924, issues. Now, after a few months of actual operation and development with this set in the field, we are ready to offer certain changes for improvement and to make certain explanations regarding peculiarities of operation. The Grimes-ed Neutrodyne was a four-tube loop set giving two stages of neutralized tuned radio frequency, a tuned soft detector tube and three stages of audio amplification.

There were many objections raised to the soft detector tube because of its one ampere "A" battery drain and also because of its hissing noise when adjusted to maximum sensitivity. It is rather laughable to confine oneself to loop operation to get away from atmospheric noises—only to create a worse and continual hissing right in the set! Furthermore, the best results, the detector tube hook-up shown in the Sep-

tember issue required a separate 22½-volt detector "B" battery. While satisfactory results can sometimes be obtained by tapping the 22½ volts off from the 90-volt "B" battery, it is liable to cause an audio howl in the set, when the "B" batteries depreciate slightly due to their increasing internal resistance. This tendency toward audio howl is increased when employing three audio stages of amplification. The "two-control" Inverse Duplex described in January, 1924, number of "Radio in the Home" showed this separate detector "B" battery. It was not shown in the Neutrodyne article. If you experienced such a howl, it is suggested that you immediately install a small 22½-volt battery to supply your de-

detector tube. Further study has been made into the question of audio transformers. We have experienced such a lot of grief from some readers on this that we had reached the stage where results could only be assured with certain definite types.

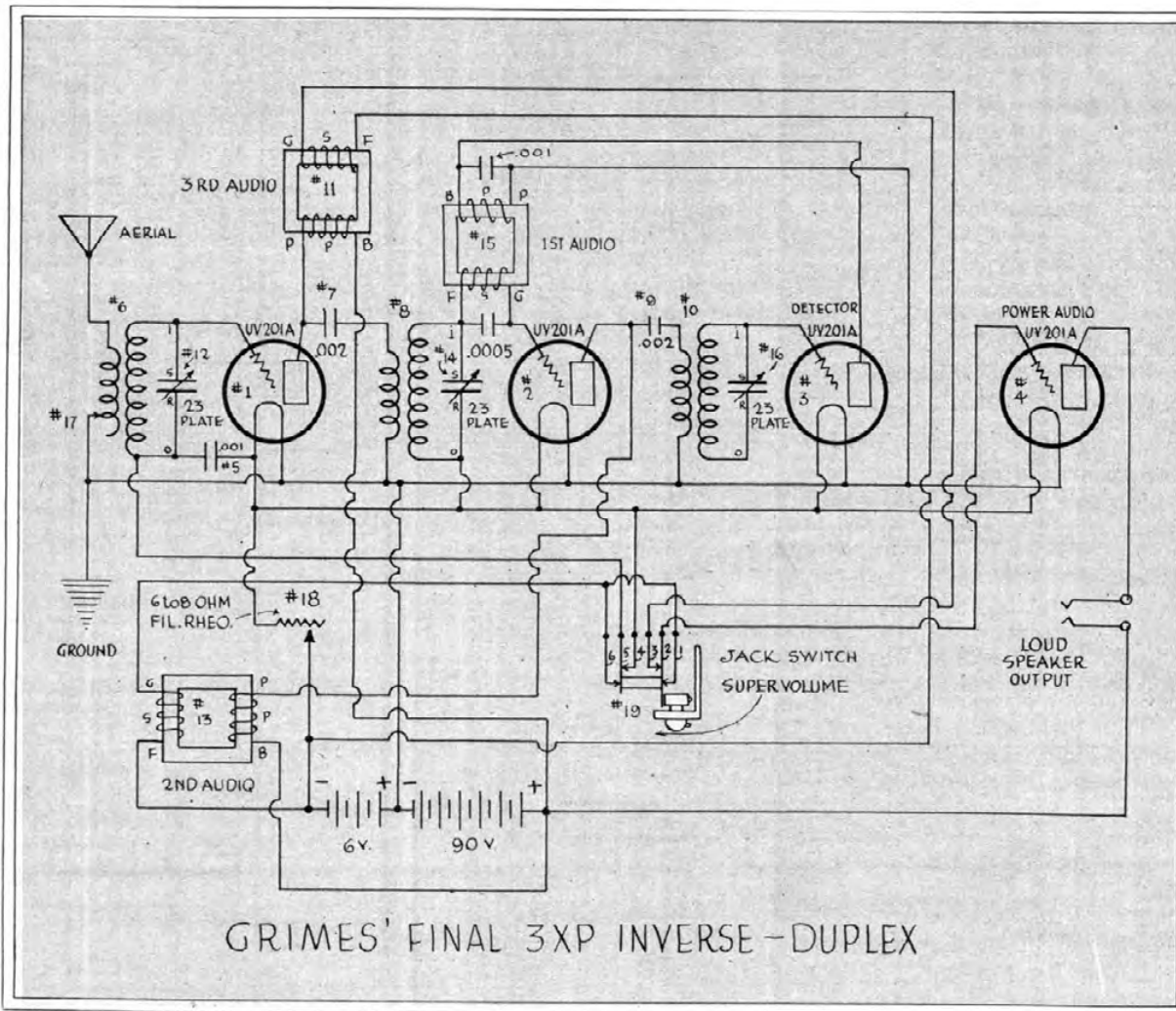

Schematic diagram. The numbers correspond to the numbers on the apparatus shown in the 3XP-style wire-ups and the check-up lists

tube instruments then on the market. This combination was called the Grimes 3XP Inverse Duplex and was described in the June and July issues of "Radio in the Home." The 3XP combination was a three-tube set, employing two stages of tuned

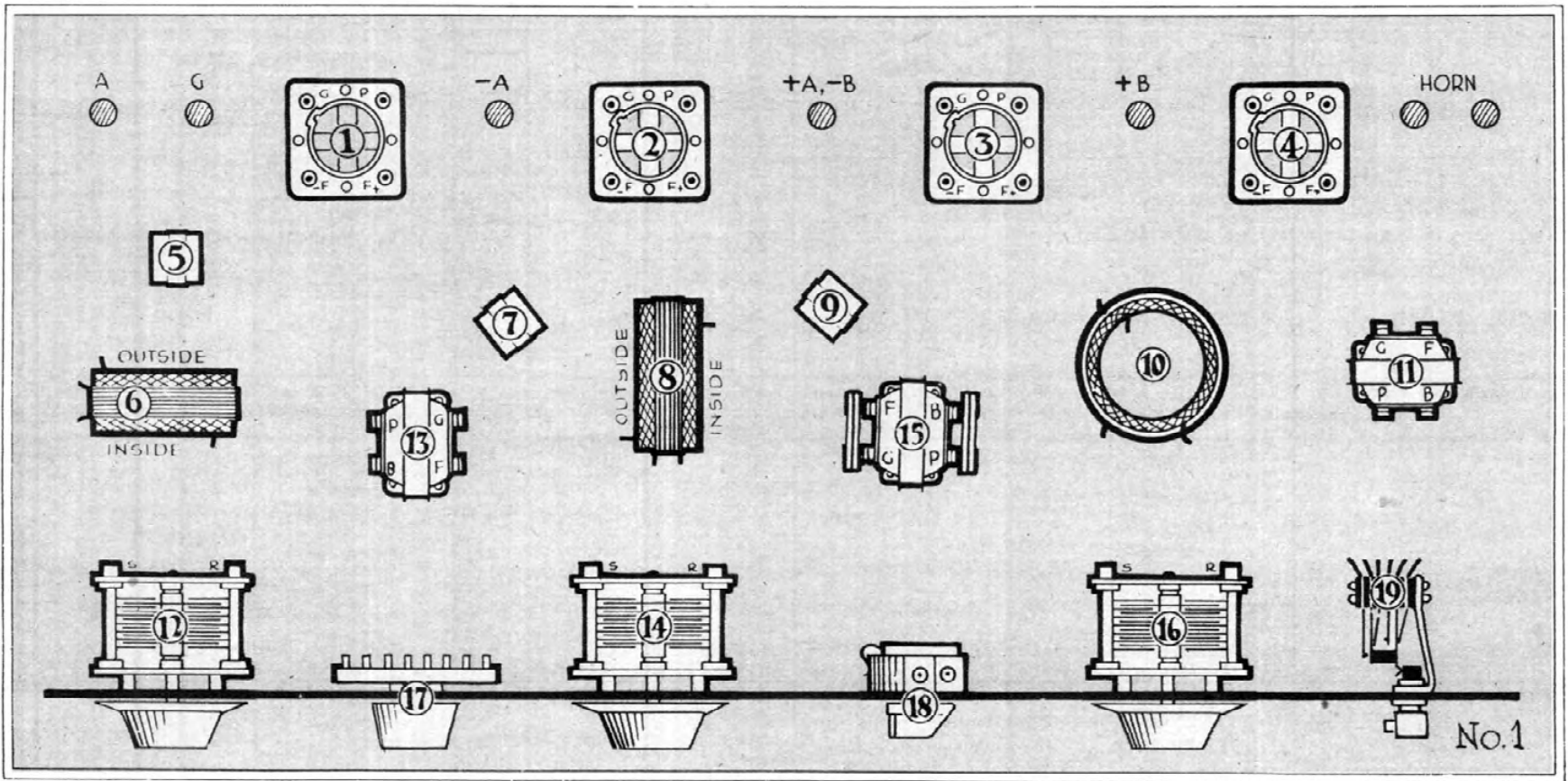

This has been absolutely chased down to its solution—and it will certainly interest many of you.

In the past we have so closely stayed to one type of audio transformer that we have been strongly accused of owning stock in the company. Now, by following the advice given below, you may use a wide variety of them, provided they are still of low ratio. We have yet to find anything that performs better than a 3 to 1 ratio. The whole difficulty has been in trying to operate too many amplifying tubes from one filament rheostat.

You perhaps know that all howls, either radio or audio, inaudible or audible, are oscillations caused by feed backs. Some-

where, in some way, some of the output energy of a tube is getting back into the input of that tube to be reamplified many successive times, building up into the howling condition. This greatly limits the possible amplification and every effort should be made to locate the cause—to apply the *right* remedy. Too often are we inclined to kill the pig to stop the squeal. Let's feed him!

The audio grid currents of the last tube, flowing as they do, through the filament rheostat into the filament, must necessarily have a path back into the grid of the second and first audio tubes where the grid circuits of these tubes also pass through the same common filament rheostat.

Economy has been our reason for using this common rheostat, but it should not be called upon to furnish a negative grid bias for all three audio stages. Certain types of audio transformers would stand this feed back without howl. Others howled and the pig was usually killed to bring about tranquillity.

The common method of performing the execution was by placing large by-passing condensers across the secondary windings. These greatly reduce the possible amplification—especially at the higher pitches. It produces the familiar nasal or throaty sound instead of a clear cut reproduction. Hear ye! Hear ye! Hear ye! From henceforth on let us never run all of the grid re-

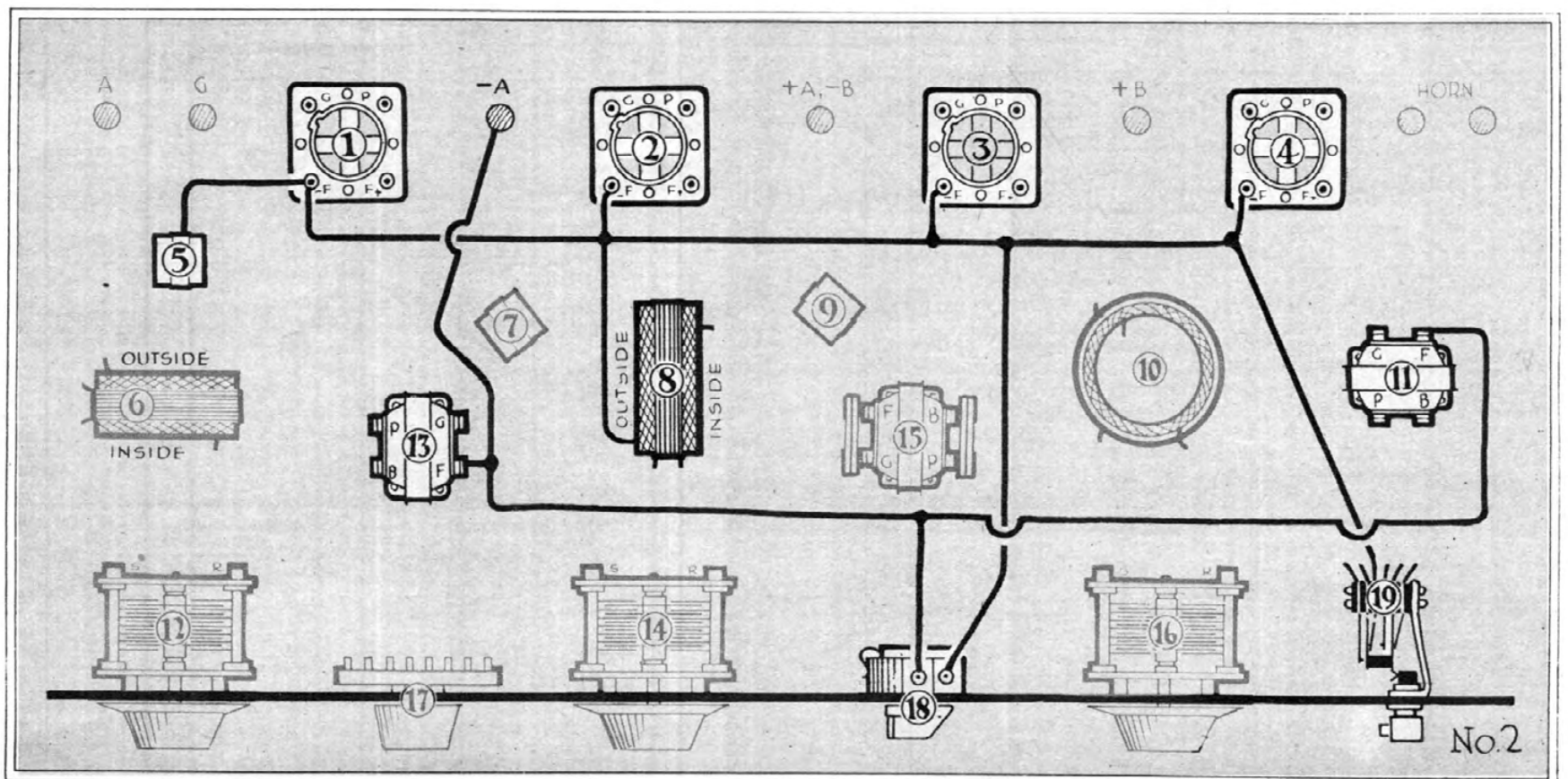

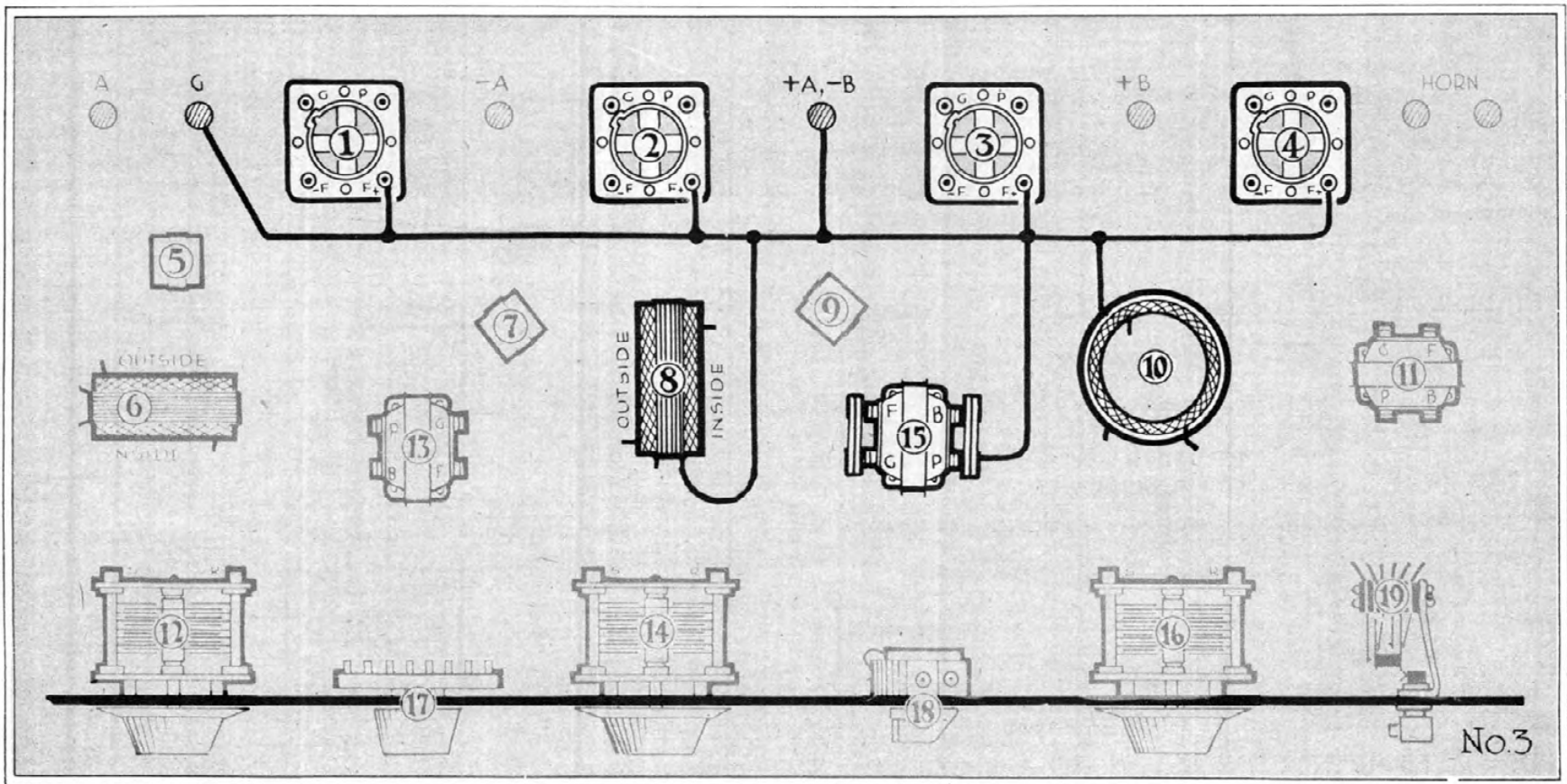

turns from the audio stages through the common rheostat! The first audio stage, having weak audio energy anyway, does not need the negative grid bias; so by running this grid to minus filament, the grid currents do not pass through the common rheostat where they are affected by other audio stages.

The reasons for the howls in some hook-ups of the Grimes-ed Neutrodyne were undoubtedly feed backs in the common rheostat or feed backs in the common "B" battery. Try returning the grid of the first audio to minus filament instead of minus "A," and hook-up a separate 22½-volt "B" battery for detector. You will then find that you will be able to decrease the amount

of by-pass capacity across the secondaries of the audio transformers and even use other makes entirely. In our experiments we are now using only .0005 mfd. across the secondaries. Much louder and clearer reception is the result. As a precautionary measure we are showing .001 across the secondary of the second audio, but reduce this to .0005 if you can without howl.

Now feed backs at radio frequencies are just as serious, although they are not quite as annoying. Any tendency for the radio energy to feed back from the output to the input of the tube will cause radio oscillation greatly limiting or reducing the possible radio amplification. This is a fact rarely appreciated by the experimenter. Radio

feed back or regeneration is not desirable in a multitube radio frequency amplifier.

There are proper and improper means for overcoming radio feed back. In other words, it is just as possible to "kill the pig" in radio as in audio amplification. In audio work, the volume is greatly reduced, while in radio amplification, distance reception fades from the picture. One sure way of doing the wrong thing is to use a potentiometer control on the grid of the tube.

Until Rice came along the feed backs were killed, rather than overcome. This gentleman studied the various causes of radio feed back and applied different remedies. In order that you may understand something about these things, we are tak-

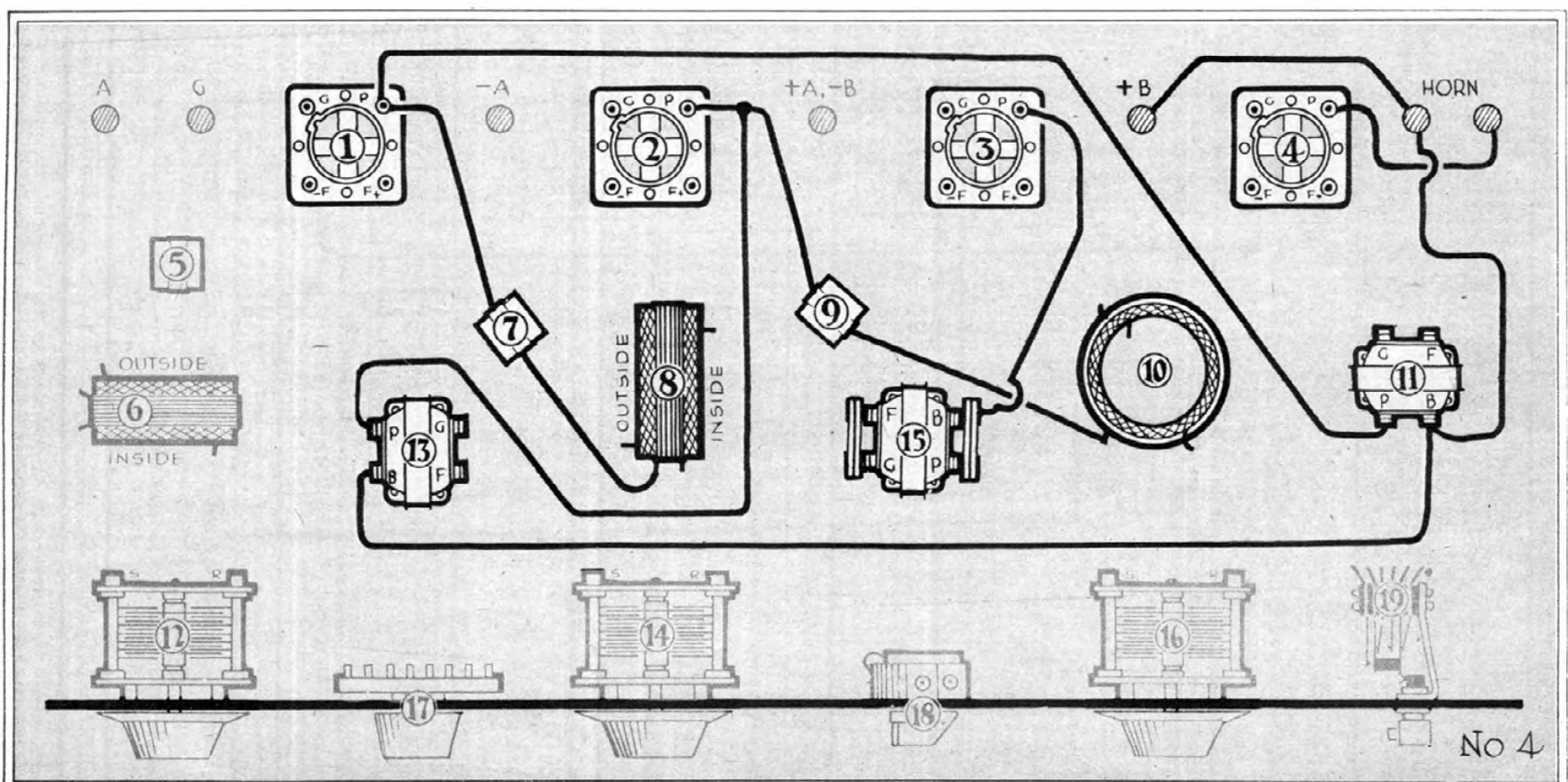

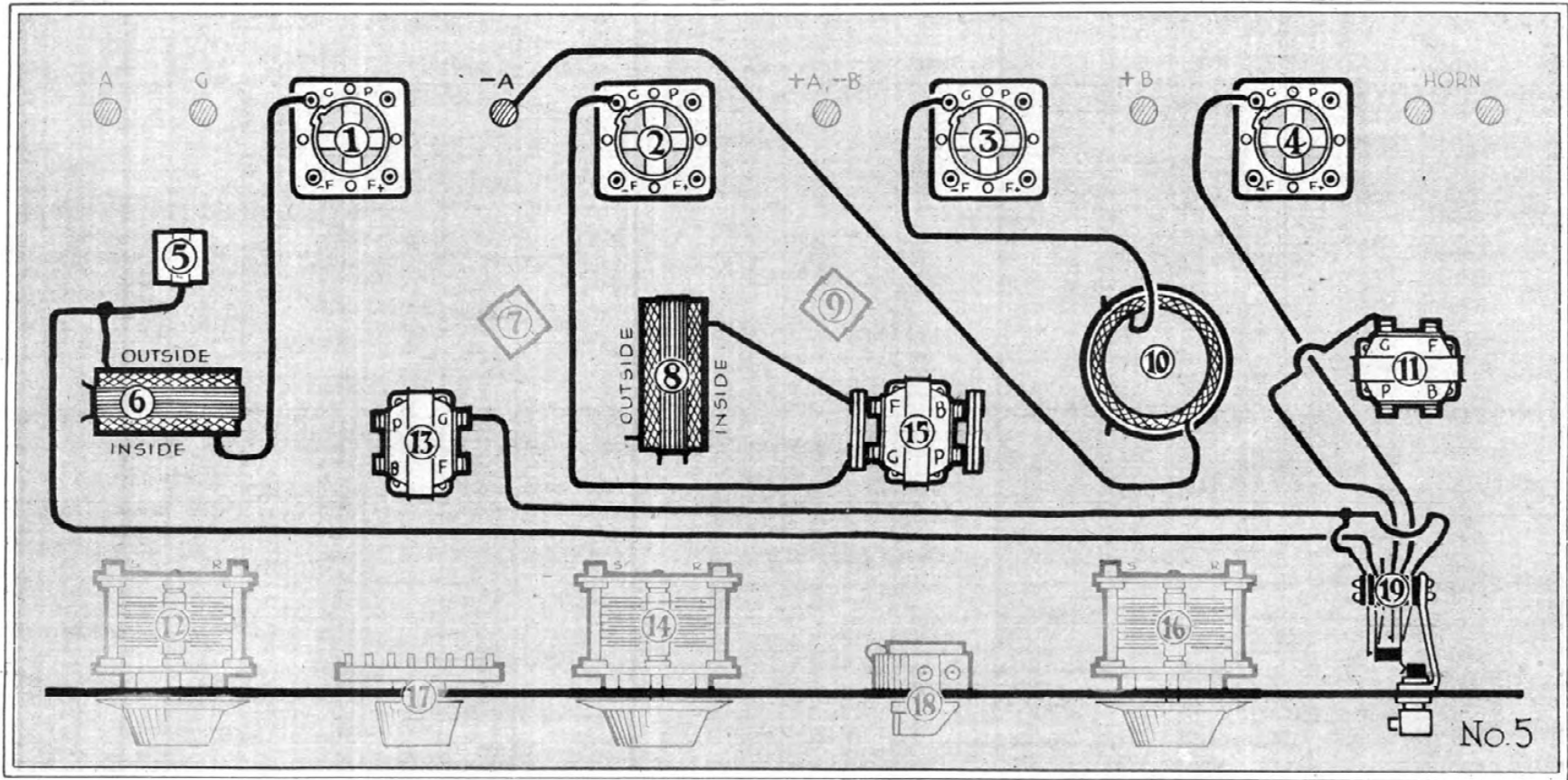

ing a little space here to explain them. Radio feed backs may be caused by—

- (1) Inductance,
- (2) Capacity,
- (3) Resistance.

An illustration of the first method is the well known "tickler coil" in a regenerative receiver. It is the feed back present when radio frequency coils are mounted parallel to one another. To eliminate this source of trouble always mount them at right angles with their centers on the same line.

The second is the feed back experienced in the old two-variometer regenerative circuit. The capacity feed back takes place between the plate and grid of the tube.

These elements act like a two-plate condenser. It may also be produced by placing tuning coils, condensers, etc., too closely together. It is entirely possible to create capacity feed back between two coils mounted closely, even though they may be at right angles with their inductive feed back absolutely zero.

A resistance feed back may be caused by any resistance that is common to two or more circuits. Such was the case with the common rheostat and common "B" batteries.

All of these sources of trouble except one may be reduced to an appreciable minimum by exercising a little care in laying out the equipment for mounting. The only

feed back that still makes itself heard even with careful circuit design, is the capacity one between plate and grid of the tube. This is a matter of physical construction of the tube and lies beyond our control. We cannot take our tubes apart; so if we are to overcome this source of feed back, a counter-balancing circuit must be introduced. Fortunately, with the other causes of radio oscillation removed, there is little need for such counter-balancing circuits and they are tricky things at best. It has been our experience that so-called neutralizing is not necessary and Mr. Pfanstiehl bears us out in this.

This, then, outlines to you what Mr. Rice and others have (Continued on Page 38)

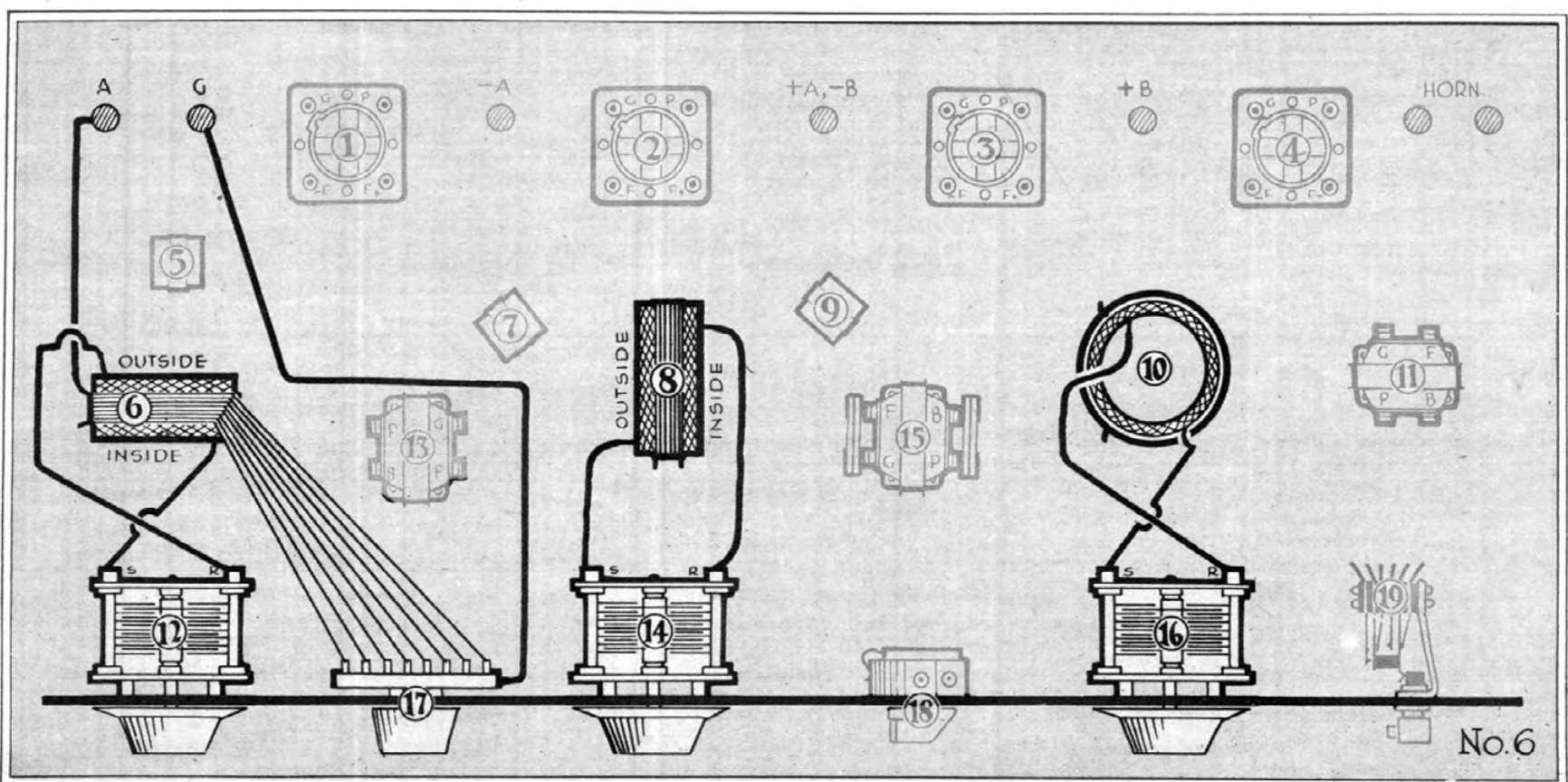



Jack Nelson and two  
new radio stars—  
Mooseheart kids

Radio's youngest di-  
rector, Bernard  
Temple, leader of  
Juvenile Band of  
Mooseheart

# Twelve Hundred Kids on the Air

By JACK NELSON

Director-Announcer of WJJD

**M**ANY fans have lately wondered what had become of Jack Nelson, who was formerly the popular star of WDAP and its successor WGN in Chicago.

Nelson has several times been voted the most popular radio announcer in the Middle West if not in the country. When he left the Chicago station, there was much speculation among the fans as to where he had gone.

This story will tell you about him. It is an interesting sidelight on a man who loves kiddies as this story shows he does. In addition to being such a popular announcer, he is both a singer and composer. He has made many hits with his song compositions, among them being "Foolish Child," "I Got a Song for Sale," "After the Storm," "You Are Too Sweet for a Dream," "Carolina" and "Sleepy Head."

His two latest seem to be becoming more popular than any of the others. These are "I Do" and "May You Laugh in Your Dreams." This latter title came from the favorite slogan with which he used to sign off from a Chicago station—"May You Laugh in Your Dreams, Dear Listeners."

H. M. N.

**W**HEN I told Ralph Shugart, our engineer, that "Twelve Hundred Kids on the Air" was going to be the title of this story he said that's entirely wrong, because he pictured in his mind twelve hundred young goats out on the Mooseheart Farm "baa-a-a-a-ing" into sixty-five microphones, in series or in parallel, as the case might be. But I insisted that the title remain the same, because it is about the best way to describe the children at Mooseheart. To me they seem to be too sturdy and red-blooded to be called "kiddies" or even children.

Before I go further let me explain what Mooseheart is and what I am trying to do there.

Mooseheart is a city in Illinois, thirty-five miles directly west of Chicago, on its own estate of 1200 acres. It is a philanthropic, non-money making institution, sponsored by the 650,000 members of the Loyal Order of Moose. The only children who are admitted are children of deceased members of Moose. They range in age from five months to nineteen years.

There are about 200 buildings in the city which include homes, grade schools, high school, auditorium, gymnasium, power plant—in fact, every kind of building nec-

essary to make Mooseheart complete in itself.

It is an ideal city where otherwise dependent children are taught not only how to make a living in future years, but also how to live. All the student enterprises which one finds in the high school of the average American city are at Mooseheart. There are bands, orchestras, glee clubs, etc., in addition to the various athletic teams. The three football teams are selected from the 65 boys in the High School and they are invincible because the boys have lived right and have lived together so that they know how to work together.

We are broadcasting programs given by these children, not to show how good





Mooseheart children are in their own lines, because most of them are mere amateurs in the study of music, but to give children in the Middle West a chance to listen-in to programs given by boys and girls of their own age. In other words—we are giving bed-time hour programs for the children by the children.

One case which came to my notice illustrates my point. A young girl in a city near Mooseheart heard one of the Mooseheart girls here one afternoon playing a piano solo. I happened to state on the air that the Mooseheart girl had taken just fifteen lessons, and the girl who was listening had just started to study the piano. Her comment to her mother was:

"Why, Mamma, I think I'll be able to play better than that when I've had fifteen lessons."

I hope she will, but the thought is that our programs will offer a standard of comparison for children in the vicinity, and if Mooseheart boys and girls do better at that same stage of the game it will serve as an urge for some other boys and girls to do better work.

I am trying as much as possible to have the boys and girls talk to me so that it can be heard by the listeners. One little third-grade boy from Pennsylvania was about to sing a little song one day and I asked him where he came from and he replied, "Bowmans-town, P. A., Pennsylvania." He evidently believed P. A. and Pennsylvania were both necessary to name the State.

We have a number of requests from relatives of children all over the country wanting to know just when their little protege was going to do something on the air, because it is quite a thrill

for a grandmother in Colorado, for instance, to sit and listen to her grandson at Mooseheart.

It is a great thrill for me to walk around the ground. No matter where I go some little bobbed head will appear in some window and say: "Hello, Jack," or I meet a bunch of the older fellows coming back from football practice and they say: "Hello, Jack." It is the spirit of cameraderie that makes it so interesting, but it seems that their attitude changes entirely when I ask one of them a question, requesting information. Then it is always, "Mr. Nelson," "Yes, sir," "No, sir." They seem to recog-

nize the fact that, while I am really one of them and sharing in their activities, yet I'm a little bit older and therefore some one to respect.

They are the happiest bunch of kids I ever saw and the radio station has added new impetus to their various activities. What a thrill for the boys on the football teams to realize that their games are the only high school games in the country (so far as I know) which are broadcast regularly from their own field, play by play, and when I tell them that my announcing of the game was heard in Alabama, North Dakota, Kansas, Connecticut, New York, etc., I really think they get a bigger kick out of it than we do at the station. It is gratifying to us of course, because day-

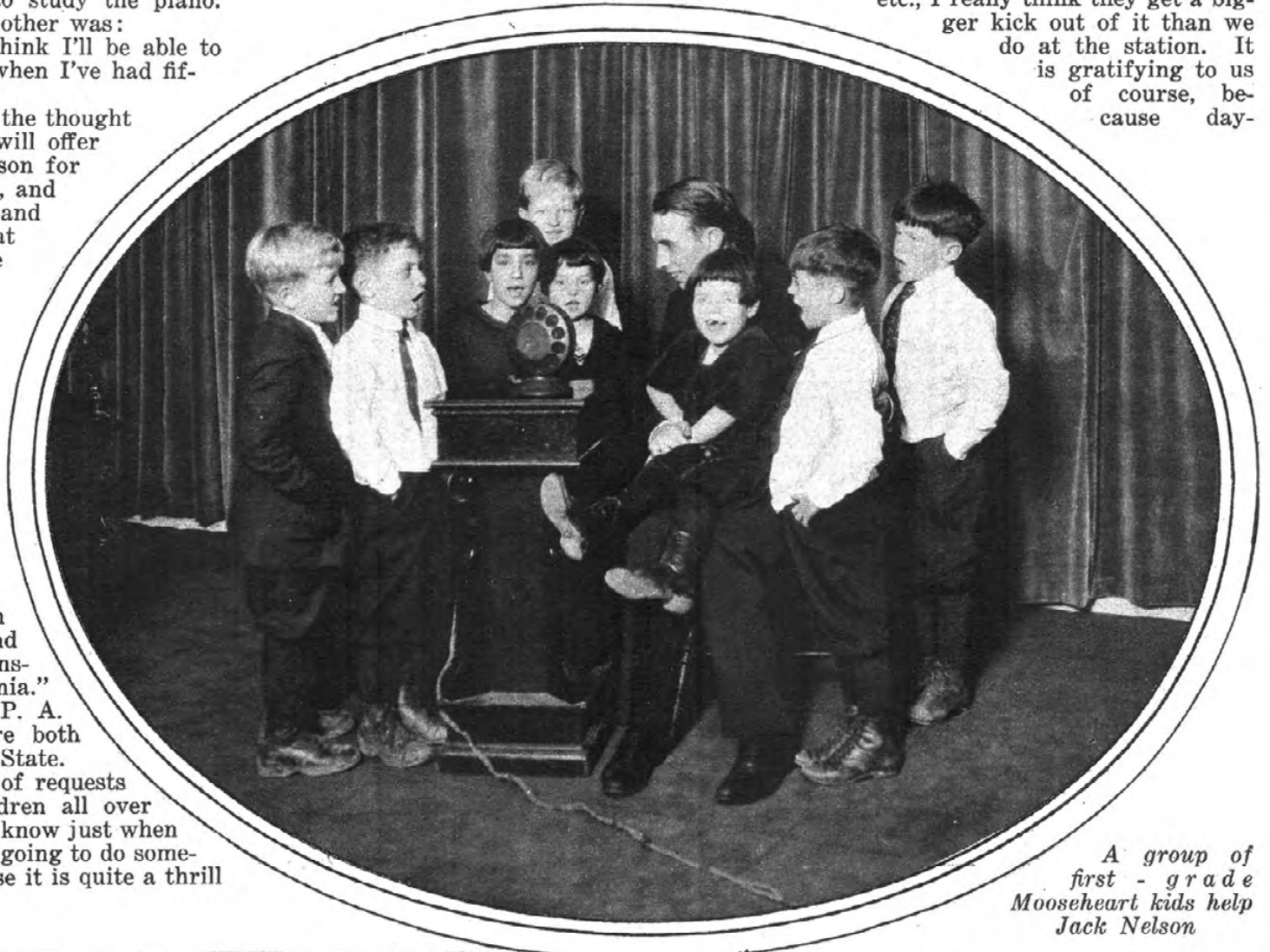

A group of first - grade Mooseheart kids help Jack Nelson

Left—Part of the Mooseheart Juvenile Band



time broadcasting of that range is unusual. At first they were a little bit frightened of the microphone, but they are getting over that and you should see a group of 7-year-old boys and girls assembled from all over the country singing for all they're worth "For the Radio," or you should see the Novelty Orchestra (it's not called a Jazz Band here), doing their best because they know they are running up against the best orchestras in the country from other stations.

The children are all very proud of their call, WJJD. The reason for it is that the station is named in honor of Secretary of Labor, James J. Davis, who is the Director General of the Loyal Order of Moose. Mr. Davis is one of those men who does not forget that he was once a boy. In fact, his own youth was anything but a rosy path, and it must have been a result of his own rise from bootblack to a member of the President's Cabinet that enabled him to dream of a City of Childhood and later to realize that dream.

By the time this article is in print I be-

lieve we'll be broadcasting regular programs from a studio in Chicago by means of telephone lines, so that we'll have programs which will appeal to all kinds of radio fans, but the Mooseheart end of it will remain the same and the programs will not be offered strictly as an entertainment feature but as a service for children and those interested in children. That is to say, that programs broadcast direct from Mooseheart will be of this type, while the Chicago programs will be strictly an entertainment feature.

For instance, for the children, as I have said, there will be programs given by the Mooseheart children or organizations of Mooseheart children, a series of talks by M. P. Adams, the Superintendent of Moose-

put me to shame by their singing of the National Anthem. They can sing two verses of the "Star Spangled Banner" and two verses of "America" without flicking an eyelash, and I wonder if there is any place in the United States with its total population able to do the same thing!

Talking about "any place in the world" reminds me that Mooseheart has the lowest death rate of any place in the world. There has not been a death at Mooseheart since January 20, 1921.

Mooseheart has a hospital, but this hospital is unique because it has few patients in it. It is a beautiful three-story building, capable of caring for 75 and with all modern equipment for hospitals. One poor little girl must stay there permanently be-

one of the first to broadcast Catholic services regularly. We broadcast the Catholic service from 7:45 until 9:00 o'clock, following which we have an organ recital of Sunday music, and then the Protestant services from 9:40 until about 11:00 o'clock every Sunday.

It is surprising to notice how quickly radio fans will recognize a new radio star. A little 7-year-old boy and a little 7-year-old girl bring in quite a few letters every time they broadcast. The incident which made the boy famous was the fact that after he sang "Over the River and Through the Woods" one night, I asked him in front of the microphone what he had for supper. He was very close to the microphone and he said, "We had CAKE." He

nearly blew the transmitter through the roof. I then found the cake was a special cake with coconut frosting in honor of his brother's birthday. His singing of "O Tannenbaum" in German was another great success which added to his reputation. A t.

(Continued on Page 44)

*The Mooseheart Novelty Orchestra, which is on the air from WJJD every Monday evening*



heart, who is responsible for the education and training of these 1200 children, whose talks are given for the benefit of parents, teachers—in fact, any one who is closely associated with children. Mr. Adams is fast becoming recognized as an authority on child care and his talks will follow along definite outlines, taking up all phases of child life and the problems attached thereto. He will go briefly into psychological tendencies of children and will carry that through to the stage of adolescence. This ought to be of great service to parents, because he will go into detail and give his advice concerning problems which every parent has to face—the "gang" spirit, the "puppy-love" stage, the "running-away-from-home" desire, etc.

Then there will be talks for the woman at home by members of the Household Science Department; talks to the high school boys on athletics by Ben Oswalt, the athletic director and football coach at Mooseheart, whose efforts are so successful in building athletic teams that it is hard for Mooseheart to fill up its football schedule.

Every afternoon we broadcast the Mooseheart Assembly, and these children

cause of some affliction she acquired in infancy. She, of course, has everything she needs and wants, including her own radio set.

Outside of this one case, the hospital has practically no patients. If one of the children develops a slight cold, sore throat or an infected finger he is immediately sent to the hospital to stay at night. During the day, however, he is allowed to go to his classes and keep up his school work, but at night he must go to the hospital instead of going to his regular home. What we call a slight ailment or even one degree of temperature is sufficient to cause him to be sent to the hospital. In this way the hospital is more of a house of prevention than a house of cure.

Because the Loyal Order of Moose is nonpolitical and nonsectarian all religious faiths are recognized. By that I mean every child is brought up in the religion of his parents. The Orthodox Jews are taken to a synagogue in Chicago for their worship and there are Catholic Mass and Protestant services every Sunday morning, and special meetings during the day for those children who belong to sects such as Christian Science, Mormonism, etc. As far as I know we are one of the few and



*Secretary of Labor, James J. Davis, Director General of the Loyal Order of Moose, in whose honor the station is named*

# Harkness Answers Questions

## on his reflex and Counterflex Circuit

SINCE the Counterflex circuit was introduced in last October's issue of this magazine I have received a great many letters from readers reporting their experiences with this receiver and asking questions about its operation.

I have been very glad to receive all these letters. I don't think I quite realized before how many of you build the sets we write about from month to month. It has been particularly gratifying to receive so many letters reporting complete satisfaction with the operation of the Counterflex. Usually, readers don't write to me except when they are in trouble! I must admit it is a pleasant experience to open letter after letter from readers who are *not* in trouble and whose only reason for writing is to express their appreciation.

The particular purpose of this article, however, is to answer the questions which have been asked by readers who encountered difficulties of one kind or another. Others who built the Counterflex have possibly been confronted with the same problems and so I hope that my answers will be of general interest and assistance. To avoid giving a false impression of the Counterflex to new readers, who might well imagine that the troubles related herein would surely befall them if they built this receiver, I shall also quote from several letters telling how well the Counterflex works.

I know you will be glad to learn that several *Radio in the Home* readers who built the three-tube Counterflex receiver immediately after it was first described in the October number, successfully picked up European stations during the international tests. This is especially interesting in view of the fact that the Counterflex had been introduced only a few weeks before the tests started and comparatively few sets had been built. The record reception was made by Mr. H.

By **KENNETH HARKNESS**  
Associate Editor of "Radio in the Home."

Berglund, of 313 No. 78th Avenue W., Duluth, Minn., who picked up Madrid, Spain, with his three-tube Counterflex. In his letter Mr. Berglund says:

"Of all the sets I have made and built, your Counterflex has produced the clearest and finest production of speech and music. It is everything you have claimed.

seem very selective. By this I do not mean that I am annoyed by interference from other stations, but when I am listening to a station and waiting for its call-letters, other stations can be heard distinctly. These are not local stations. My condensers are not of the best type; perhaps this is my trouble. I am using UV-199 tubes and am by-passing the reflex transformer with a .0005 Mfd. fixed condenser."

**Answer to Question No. 1**—The effect described is perfectly normal and is not due to incorrect wiring. Signals will be heard with the detector tube removed if they are strong enough to be rectified by the reflex amplifying tube.

**Answer to Question No. 2**—It would appear that the distant stations you hear

are transmitting on approximately the same wavelength as that to which your receiver is tuned. If, as you say, you are not troubled by interference, I would be inclined to let well enough alone. Good condensers, of course, will improve the selectivity of your set.

I am glad to see that you experimented with the by-pass condenser across the secondary of the reflex transformer and have apparently found the correct value for your set. The UV-199 tubes have a low internal capacity; consequently, the coupling between the plate and grid circuits of the reflex tube is considerably less than in a set with 201-A tubes. In other words, with 199 tubes there is less

positive feedback or reaction. With 201-A tubes the reaction is so strong that self-oscillation takes place when the two tuned circuits are adjusted to the same resonant frequency, even though the audio-frequency transformer coils included in the plate and grid circuits of the reflex tube cause these circuits to possess a fairly high resistance. With 199 tubes the reaction is not nearly so strong and the resistance of

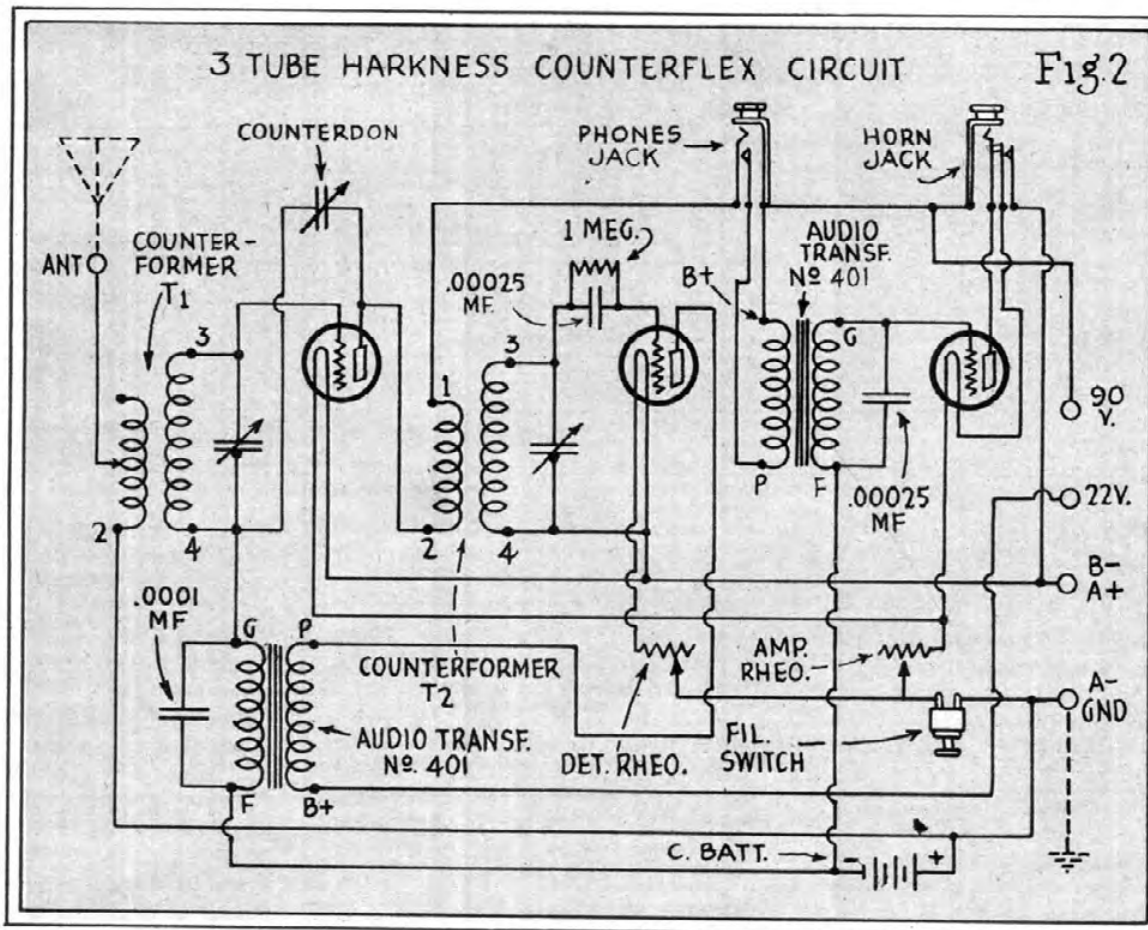

"On November 27, 1924, I picked up Madrid, Spain, at 10:35 P. M. Central Time. \* \* \*

"There are two questions I would like to ask:

"Question No. 1—I can remove the detector tube and still hear signals or concerts fairly well. Does this receiver act this way, or is my wiring at fault?

"Question No. 2—The receiver does not

the grid or plate circuits of the reflex tube can be reduced without producing uncontrollable self-oscillation. By increasing the capacity of the condenser across the secondary of the reflex audio transformer you decrease the resistance of the grid circuit of the reflex tube and improve the efficiency of your receiver. As a result, self-oscillation probably takes place when the circuits are tuned to the same frequency, but this self-oscillation can be controlled by the counterdon.

Frederick N. McKenzie, of 228 Collom street, Philadelphia, was also successful in the International tests, but has some troubles. He writes:

"Being a follower of your most efficient circuit since it was first introduced and a great admirer of same, it was quite natural that I followed the three-tube Counterflex.

"My results were remarkable, bringing in three English stations during the tests, two of which I am certain of as I got the call letters distinctly.

"Now it does not sound reasonable to say a set is not working right after such a performance, but I am troubled very much with over-oscillation and growls that nearly knock the head off me. I seem to get an open-circuit hum. This hum is only evident when the set is not oscillating.

"Should I have a separate control for a DV-2 which is acting as detector?"

"This set is, I believe, the best yet. I can separate WDBH from WTAS — take either one I want."

Answer: You do not describe the faults very clearly, but I take it you are troubled by "growls" when the set is oscillating, but that you are able to stop these growls by

damping out self-oscillation with the counterdon. Besides this, however, you hear a steady hum, even when self-oscillation is not taking place.

The first effect is normal. When radio-frequency self-oscillation takes place in a reflex circuit an audio-frequency "oscillation" is generally set up at the same time. A rather complicated modulation effect results which causes an unpleasant howl to emanate from the phones or loud speaker. So long as self-oscillation can be controlled, however, there is no reason why this howl should be troublesome. After a little practice you will find you are able to set the counterdon at such a position that you can tune in without producing a howl. When you hear a station and want to increase the audibility you can do so by turning the counterdon dial to the left. Before tuning in for another station you should turn the counterdon dial back to its former position.

The steady hum you describe is probably caused by the long leads you are using. I notice, in the plan of your set, that your grid and plate leads, which should be very

short, are extremely long. Moreover, the grid and plate leads of each tube should not run parallel to each other or to the grid and plate leads of the other tubes. I would suggest that you move the audio-frequency transformers closer to the tube sockets and shorten up your high potential wiring. Also connect a .00025 mfd. fixed condenser across the secondary of the second audio-frequency transformer. You should certainly use a separate rheostat for the detector tube. It will enable you to control rectification and audibility.

R. John Spooner, of East Aurora, N. Y., obtained very excellent results with his Counterflex, picking up Oakland, Calif., and in his letter he brings up some interesting points. He writes:

"I have built sets from most of the well-known circuits that have been published, from the crystal set up, and I have come to believe that the three-tube set is to be preferred to the more complicated hook-ups, so when I read the announcement in the September *Radio in the Home* that a new Harkness circuit was

I cannot tune out the howl in some cases. Perhaps a shorter aerial will also help this.

"I have a five-tube Cockaday which I have found the most selective of any set I have used, but its volume does not compare with this, for the two tubes of your set give more volume than three on the Cockaday."

Answer: In answering this letter I am going to discuss the "selectivity" of the Counterflex at some length, as quite a number of correspondents have asked how to make their sets more selective.

The selectivity of a receiving system is one of the two most important factors which determine its efficiency, the other being its "audibility." If the system has very high audibility but poor selectivity, it is of little use. There is no advantage in being able to hear hundreds of stations within a range of several thousand miles if one hears them all at the same time. On the other hand, if a receiver has extremely high selectivity but very poor audibility it may be equally inefficient. In some cases these two qualities are inversely proportional to each other. If the audibility is increased the selectivity may be proportionately decreased and vice versa. If this condition exists, the designer or the operator of the system, as the case may be, should seek to obtain the highest possible selectivity compatible with reasonable audibility.

Now, while audibility and selectivity are the two most important qualities of a radio receiver, there are other important factors, such as simplicity of operation and cost of construction, which one has to take into consideration. When I was designing the three-tube Counterflex receiver I could very easily have added another control and made the set much more selective without decreasing its audibility, but I decided to have only two wave-length controls because the added control would have made the set more expensive to construct and more difficult to operate. Of course, if I believed the added control necessary I would have included it, but I maintain that the Counterflex, as it stands, is sufficiently selective in the vast majority of locations. Only those who live within a very few miles of several powerful broadcasting stations require greater selectivity than the Counterflex affords.

If your location is such that you require more selectivity there are several methods you can use to obtain it. The simplest way is to connect a small fixed condenser (about .0001 mfd.) between the antenna and the antenna binding post of the receiver. This decreases audibility, but the audibility of the three-tube Counterflex is so unusually high that you can well afford to sacrifice some of it to gain greater selectivity. Another

(Continued on Page 50)

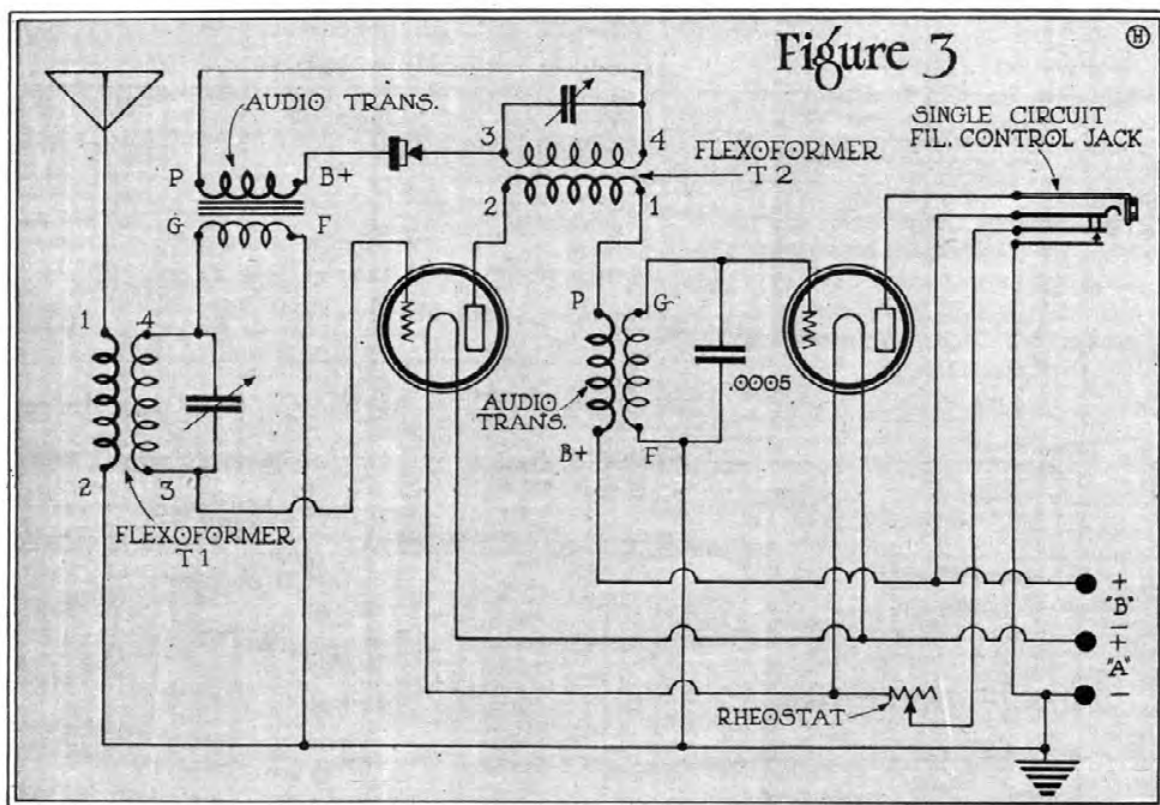

coming in the next issue, I anticipated something good, having tried the first Harkness set.

"As soon as the October number was received I got out the flexoformers wound for the former reflex circuit, rewound them as described and wired up a set on an old panel.

"On the first tryout, Dallas, Tex., Kansas City and two Chicago stations came in loud and clear, and WGR (eighteen miles away) was almost too loud for comfort on the two tubes with earphones. Last night KGO (Oakland, Calif.), came in quite distinctly although the static was very bad.

"The set is not as selective as some I have used as WGR and KDKA cannot be separated and can be heard over a considerable part of the dial. Perhaps my aerial is too long.

"I noticed in one of the diagrams that the primary coil was tapped in the center although this was not explained.

I also find that the Chelton midget does not seem to have quite enough capacity, as

# Polishing the Door Plate

"ADVERTISING," says Mr. George Podeyn, of Station WEAF, "means polishing the door-plate so that it catches the eye of every passerby."

This indicates a double need—a conspicuous place for the door-plate and an excellent polish.

What more conspicuous place could be found than in a broadcasting studio where it can catch the eye (or the ear) of a half-million people in an evening, and what better polish than a team like the "Happiness Candy Boys" or a "Packard Travel Talk"?

Will the same position of prominence serve the needs of a variety of firms selling articles widely different in type, price and practical value? Will it serve them so well that these firms will go on purchasing the facilities of WEAF and thereby providing the radio audiences with entertainment of an exceptionally fine caliber?

"Yes," says the American Telephone and Telegraph Company, as a matter of course.

"Yes," says Mr. Gunnison, of the Stanley E. Gunnison, Inc., Advertising Agency, whose business it is to find the best media for publicity.

"Yes," say the companies which are using the facilities.

But, after all, the important thing is, What do you listeners-in think? Your answer is on every applause card you send in.

It is probable that when you take your next automobile trip you will be driving a "Packard Eight"—with the sole proviso that you have the price! And even if you are driving a good old Henry, you will undoubtedly be saying as you hit the bumps:

"Before another ten years, you bet I'll be driving a 'Packard' like that Cooley fellow who gives the travel

By **GOLDA M. GOLDMAN**

talks." To signify their approval, the kiddies in the back seat mumble through mouths full of \* \* \* well, what but "Happiness Candy"? Whether Daddy owns a "Packard" or a "Ford" matters little at 8 o'clock of a Friday night, when "The Happiness Candy Boys" do their stuff for the

radio audiences, so candy has come to mean to them happiness in both senses of the word.

All this indicates just one thing. Two companies have succeeded in keeping their brass plates very bright indeed. They are firms that are as far apart as the Poles. One handles a portable article that you may purchase for as little as five or ten cents a package. The other produces a luxurious piece of machinery that you can buy only when you have three thousand dollars rattling around in your pocket. One you buy carelessly, quickly, when the spirit moves you—for a nibble, for a party, for a gift, for a peace-offering for the wife, for a treat for the kids. The other you buy after long thought and much consultation, and only once or twice in an ordinary man's lifetime. Yet the radio studio is proving a truly remarkable point of vantage for every firm using it, as is typified by the results

obtained by these widely divergent interests. It merely resolves itself into a question of exercising the most tremendous care in choosing the polish. What a shine "The Happiness Boys" have given the brass doorknobs of fifty-five stores! What a gloss Mr. Cooley has preserved on the Packard door! Can you imagine any one being reminded of a brand of sweets by an hour-long lecture, or picturing the luxurious ease of a motorcar by the ministrations of a jazz orchestra? Reflect for a moment on the psychology of associating candy with the ever-joyous, bubbling fun of Billy Jones and Ernest Hare, and of linking a Packard car with remembered accounts of delightful motor trips through Berkshires and Adirondacks.

Mr. George Podeyn, who is the commercial representative of WEAF, and account executive for WEAF for the Happiness and Packard accounts, worked out the ideas for these two features in conjunction with the Gunnison agency.



ONE POUND NET

UNITED HAPPINESS  
CANDY STORES

*The Happiness  
Candy Boys,  
Billy Jones and  
Ernest Hare.  
Their clean, whole-  
some fun and song  
have made them the  
invisible idols of  
thousands of radio  
fans*

George E. Cooley, well-known traveler and lecturer, and Bill the chauffeur, who weekly carries his great invisible audience in his Packard Eight up hill and down dale through beautiful scenic America

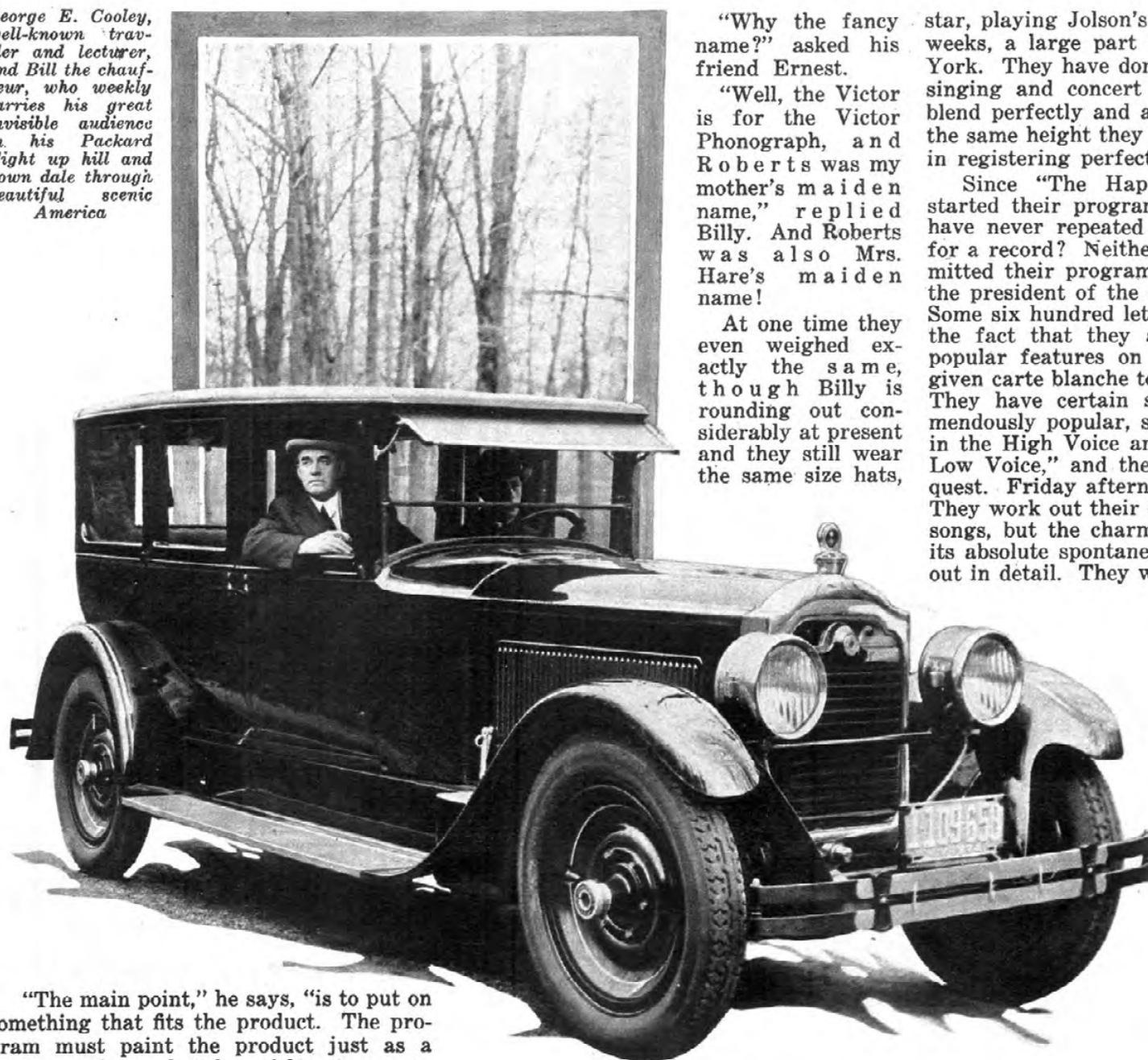

"The main point," he says, "is to put on something that fits the product. The program must paint the product just as a painter paints what he wishes to represent."

For this reason, it is necessary for Mr. Podyn to have his ideas all worked out before he sells the facilities of the station to Happiness and Packard or any of his other accounts. In these particular cases, the man he had to deal principally with was Mr. Stanley E. Gunnison, of Stanley E. Gunnison, Inc., Advertising Agency. Mr. Gunnison's agency was the first to recognize and admit the value of radio as an advertising medium, and he, himself, is progressive enough to realize the fact that this method, while appearing indirect, can still be made subtly direct. We will come back to this point later.

Meanwhile, let's have a look at these "Happiness Candy Boys," who give us so many happy hours. In some ways they should be called the "Happiness Twins." One day early in their partnership, Jones said to Hare:

"Tomorrow is my birthday."

"Go on," said Hare inelegantly, "it's mine!" And it was, for they were born on the same day, though not the same year. And here's another funny one:

Both boys made records for talking machine companies (sixteen different kinds at present), and did so before they knew each other. Hare was making bass records and Jones, tenor, when they decided there was a good field for duets and joined forces. Jones was singing, at the time, as Victor Roberts.

"Why the fancy name?" asked his friend Ernest.

"Well, the Victor is for the Victor Phonograph, and Roberts was my mother's maiden name," replied Billy. And Roberts was also Mrs. Hare's maiden name!

At one time they even weighed exactly the same, though Billy is rounding out considerably at present and they still wear the same size hats,

collars and coats. That makes it easy for the folks who want to send them "fan" presents, and fortunately for the boys there are plenty who do.

But the most amazing part of all this is that, despite their similarities, they could never by any chance be confused, for they are utterly unlike in appearance. Billy is the round, jolly man-about-town, who likes his clubs and the night life, drives his roadster and keeps his country house up in Brewster, and has never been foolish enough to get married. Ernie, on the other hand, is leaner in appearance, with one of the most carefully brushed bald heads in Flushing, and, indeed, looks for all the world like a professor with his spectacles and quiet manner, until he surprises you completely by breaking out into the most engaging of twinkles and jazzing with as much vim as his side partner. And "Happiness" to Ernie means Mrs. Hare and a 15-month-old daughter who is certainly going to be a toe dancer. Before they went into the phonograph record business, both boys were on the stage. Jones was in vaudeville for eight years with Bert Grant, the song writer, and appeared on both the "Keith" and "Orpheum" circuits. Hare was with ten of the "Winter Garden" productions. His last show was with Al Jolson in "Sinbad," in which he understudied the

star, playing Jolson's part for over twelve weeks, a large part of that time in New York. They have done light opera, church singing and concert work. Their voices blend perfectly and as they are of exactly the same height they have no trouble at all in registering perfectly on the records.

Since "The Happiness Candy Boys" started their programs last October, they have never repeated a joke. How's that for a record? Neither have they ever submitted their programs to any one, or met the president of the firm employing them. Some six hundred letters a week testify to the fact that they are one of the most popular features on the air, so they are given carte blanche to do what they please. They have certain songs which are tremendously popular, such as "You Tell 'em in the High Voice and I'll Tell 'em in the Low Voice," and these they repeat on request. Friday afternoon is rehearsal time. They work out their cues and practice new songs, but the charm of their program is its absolute spontaneity so it never works out in detail. They write their own double versions and turn the songs to fit themselves. Every week they have a new opening verse of "How Do You Do." The boys are fortunate in having as their accompanist Dave Kaplan, of the Edison Recording Company, who makes all the musical arrangements for both their recording and their broadcasting. Dave is pretty clever at the piano and he has to think fast to keep up with all

the stunts the boys interject into their programs. Last year Dave was with the "Lucky Strike" and "Chiclets" orchestra, so he is an old-timer to the radio audiences. He is American trained, a graduate of the New York College of Music and makes arrangements for the Schirmer Music Publishing Company.

The Happiness Candy Company says "Happiness in every box." The Happiness Candy Boys say, "Happiness in every home."

Now there is no question that their programs get across to you and create good will toward the firm they represent. Again I repeat my question: Can this same attitude of good will be created by a firm of an absolutely different caliber such as the Packard Motor Car Company?

The most convincing answer comes of course from the letters which Mr. Cooley receives after each talk, so I will quote from some of them:

"A few days ago I returned from a two months' vacation at Bethlehem, N. H., and I have also motored to several of those beautiful places you mentioned. You surely have said everything that is true of that glorious country.

"I live in Connecticut and can imagine the beauty of the hills and lakes as you describe them. They just seem to thrill



your soul. They make you realize what beauty we have in our United States.

"Virtually all of us in this office are radio fans and usually the first topic of discussion brought up at our round table at luncheon on Fridays is the Packard tour of the night before. Some one is sure to be reminded of a particularly bad hill that gave him trouble on such and such a time, but which does not seem to exist for the Packard Eight. One thing that we all agree upon is that the Packard Tours are very refined advertising and welcomed over the radio. I hope the touring will continue, but please make some of these trips in the Packard Six."

This is the sort of thing which indicates the extent to which the development of good-will is successful. Of course, just as it is true in the case of the Happiness Candy Boys, the type of entertainment provided is typical of the commodity being sold.

This "Packard Travel Talk" is one of the most skillfully arranged entertainments that has been provided in any broadcasting station up to date, and is, so far as I know,

*Right below is William Elliott, advertising manager of the Packard Motor Car Company of New York, whom radio fans may thank for supplying Mr. Cooley's educating travelogues touring in the Packard Eight*

*Lower left is Stanley E. Gunnison, president of Stanley E. Gunnison, Inc., which advertising agency handles the Happiness and Packard Radio program*

entertainment, as never before has so marvelous a way of teaching history and geography been found. His talks cover a wide territory, including the Berkshires and Adirondacks, New York and New Jersey. His listeners-in are on the lookout to catch him in any slips he may make. For instance, he mentioned catching "a string" at Paul Smith's. A fan immediately wrote him that he could not possibly have caught trout there at that season. Mr. Cooley responded as promptly that it had been a string of perch—he hadn't mentioned trout.

"Bill the chauffeur" has also become familiar to the audience, and it is pleasant to know that there is a real Bill—a Packard demonstrator and a rare good fellow. Mr.

Cooley has a delightful gift of both narration and description, as one or two excerpts may show. Here is one from his opening lecture:

"Unwilling to leave the fascinations of the Adirondacks quite yet for the allurements of the green and white mountains beyond, we make our way south to Westport. From here we can go down the historic

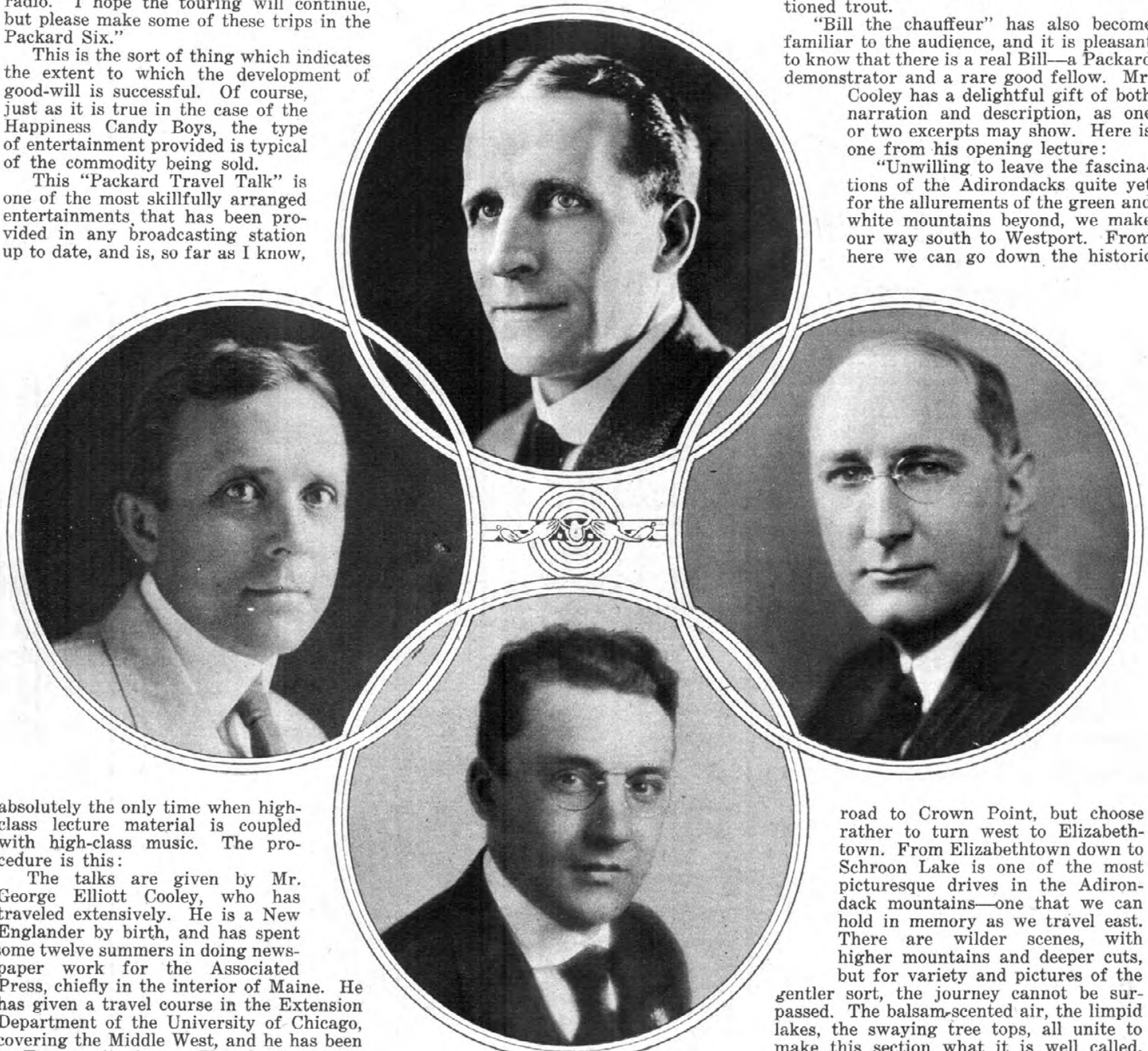

absolutely the only time when high-class lecture material is coupled with high-class music. The procedure is this:

The talks are given by Mr. George Elliott Cooley, who has traveled extensively. He is a New Englander by birth, and has spent some twelve summers in doing newspaper work for the Associated Press, chiefly in the interior of Maine. He has given a travel course in the Extension Department of the University of Chicago, covering the Middle West, and he has been to Europe six times. Thus he is able to give the proper enthusiasm to his talks as he describes territory and trips with which he is personally familiar.

Besides his lecture work, which has included work for the New York Lecture Bureau, he has a great deal of actual teaching experience, as he is now assistant principal of the Stuyvesant High School, one of the largest high schools for boys in New York City.

In these talks, which began on October 1, Mr. Cooley feels that he has a rare opportunity to combine education and en-

*Right above is George Podeyn, account executive of WEAf, whose constructive work has resulted in the many interesting, entertaining programs broadcast nightly by national advertisers*

*Upper right is Irvin Fuerst, vice president and director of the Happiness Candy Stores, Inc., whose foresight in employing the Happiness Candy Boys to broadcast their entertaining fun made his company the real pioneer in radio advertising*

road to Crown Point, but choose rather to turn west to Elizabethtown. From Elizabethtown down to Schroon Lake is one of the most picturesque drives in the Adirondack mountains—one that we can hold in memory as we travel east. There are wilder scenes, with higher mountains and deeper cuts, but for variety and pictures of the

gentler sort, the journey cannot be surpassed. The balsam-scented air, the limpid lakes, the swaying tree tops, all unite to make this section what it is well called, "Switzerland in miniature." Just as the lengthened sun rays bring the cooler air of the late afternoon, Bill pulls the car up before the Brown Swan Club."

But as I said before, the most unusual thing about these talks is that they combine lecture and music. After Mr. Cooley has written his lecture, he sends it into WEAf. There Mr. Gerard Chatfield, who is assistant to the program director, takes it and decides where the musical numbers can best be interpolated. He is peculiarly fitted to this role of impresario because, through his work, he is enabled (Continued on Page 51)

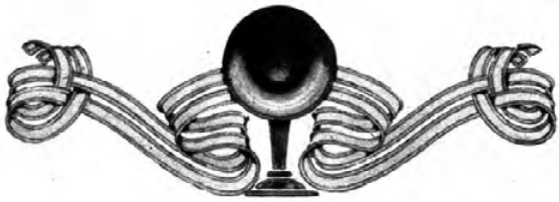

# Reception with the Flewelling Circuit



THERE are so many ways and manners in which a radio receiver may be used and so many diversified results obtained that I feel that we can accomplish the most good for our readers if I devote this article to a talk on how to use the Flewelling Circuit and say a little concerning some of the peculiarities of radio reception.

In the first place, you will want to know how to connect your Flewelling receiver to an antenna, loop, etc., and we will take that as the first part of our article.

The Flewelling receiver may be operated in either of two ways: first as a super-regenerative receiver and secondly as a plain regenerative receiver. In either case, because of its regenerative feature, it is capable of causing disagreeable whistles, etc., in your neighbor's receiver, and we must take such precautionary measures as we can to reduce this liability. If it were necessary to listen to wonderful music via radio to the accompaniment of raucous whistles, shrieks, etc., that were caused by radiating receivers, we would soon lose any desire to be so entertained. The greatest offenders in this field are the "Rolls Royces" of radio—the super-heterodynes—with their galaxy of tubes, and the humble little one-tube regenerative receiver; the two most sensitive receivers known to the art.

Now, per dollar invested, we are not able to get more out of radio than the single-tube regenerator can give us, and while there is no known means of entirely eliminating its disagreeable radiating feature, we still can cut this down to a point where it will no longer be apt to bother our neighbors. It so happens that perhaps the best method of doing this, and one that is coming more and more into use, has been in use for years, and among others was described by myself in my articles of some two years ago.

The method consists of connecting the grid or antenna post of your receiver to

the antenna through a very small fixed capacity. It is not possible, to my knowledge, to buy in the stores such a small capacity as is needed, but it is an exceedingly easy one to make, so that we need not worry.

The condenser or capacity has only two plates, one connected to the antenna post of the receiver and the other connected to the antenna, as shown in Fig. 1. The plates are the size of a one-cent piece and one can cut small metal pieces of this size quite easily. Placed face to face, the two metal pieces should be separated from  $\frac{1}{4}$ " to 1" apart, suitably fastened according to one's taste and preferably so that the distance between them may be adjusted for proper tuning of the receiver.

Soldering a bit of bus bar to the backs of each piece and using binding posts for mounts, as shown in Fig. 2, will answer

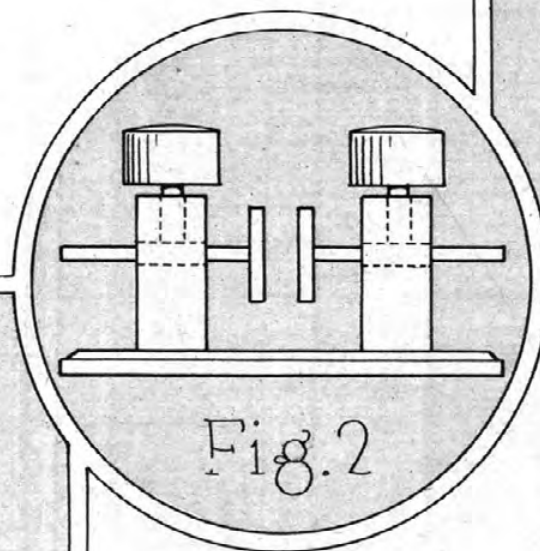

Fig. 2

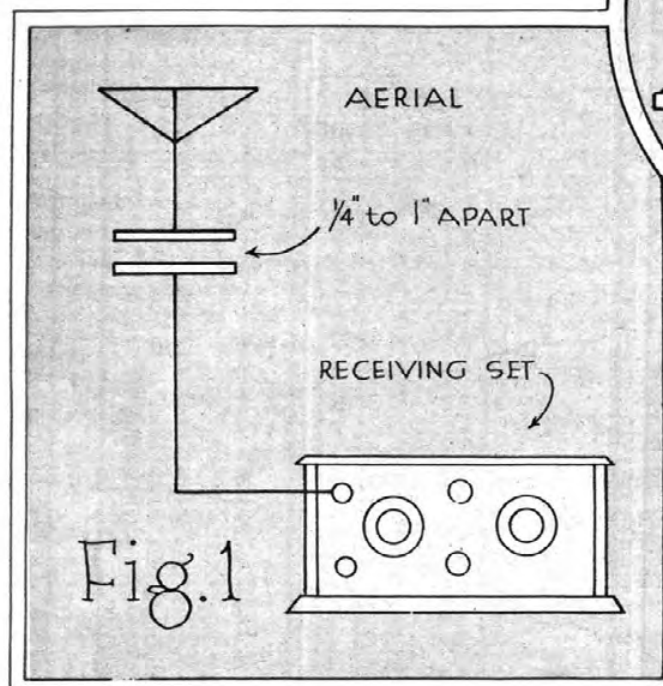

Fig. 1

nically. While the above is suggested for use with the Flewelling receiver, it can also be strongly recommended for all types of regenerative receivers and especially for those fans who are experimenting with short waves.

Antennas (or antennae, if you prefer) of all kinds, such as one wire, two wires or more, loops, etc., and even in some cases the ground itself, may all

be classed under the easy-to-remember term, "energy collector." In a vacuum-tube type radio receiver, the grid terminal of the tube is the place from which all action in the set starts. Therefore, we must do everything that we can to place upon the grid of the tube whatever is delivered to us by our energy collector.

The grid, however, is an exceedingly delicate and fussy little thing and may be unduly influenced if we connect it directly to a large lumbering antenna or energy collector. That is why we see so many ways of connecting the antenna to a radio set. Our little metal plates, acting as an adjustable condenser, however, serve as a means of transferring the incoming signal from the antenna to the grid of the set without directly imposing upon the grid other undesirable characteristics that may be possessed by the energy collector. Once set at the best point (and this is extremely easy to do), we need never change the

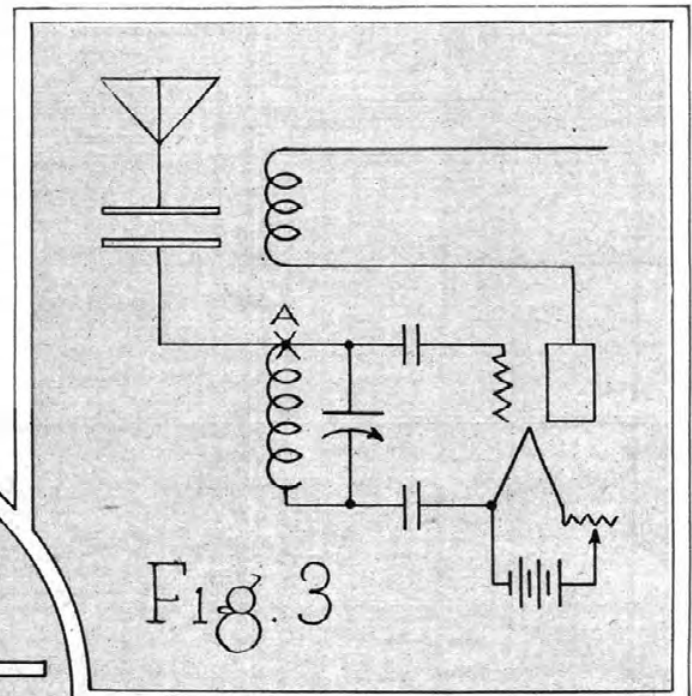

Fig. 3

distance between the plates.

Referring to Fig. 3, the Flewelling Circuit, the point marked "A" is the place to connect whatever energy collector you are to use. If you wish to use both ground and antenna, then connect the ground directly to the negative battery post on your "A" battery and connect the antenna to the point "A" on the set.

We will want to know how to get maximum volume out of the receiver, and because you have the design and specifications of the receiver from the previous article, you must do this by experimenting yourself. It will be done by proper choice of a 201 A tube, proper filament setting, and "B" battery voltage, and the setting of the grid leaks R 1 and R 2; all of which can be done in a very few minutes and should be done while using the receiver with the tickler coil well removed from the tuning coil. In other words, adjust your Flewelling receiver as a plain regenerative



receiver and then try the *super* qualities by advancing the tickler coil and further adjusting the grid leaks.

Now I know your next question, "What will it do?"

The answer is that, properly handled, it will do a bit more than the other types, remembering, however, my previous statement in *Radio In The Home*, that used as a super-regenerator it will do more than the other only at the expense of quality, etc. As a plain regenerator it need take its hat off to no other receiver. This last not because it is a Flewelling Circuit, but because it is a plain regenerator of the best type.

How many of my readers know the condition in which a radio wave reaches them? Is it strong, smooth, undisturbed, powerful? Or has it literally fought its way to the receiving set, arriving weak, badly ruffled, torn, jagged, ragged and panting? We all know how friend neighbor gets it on his receiver; of course it's the first way! However, when you want to know what to expect from any receiver it is well to remember that, even though you are but five or ten miles from the transmitting station, the wave had to fight its way to you through local atmospheric conditions, electric light, telephone lines and, for want of a better name, the so-called "dead spots." Perhaps the most valuable thing that I can give my readers in this article is a bit of illustration as to how this actually works out.

My own radio transmitting station, 9XBG, has been reported throughout the United States and Canada as "very loud."

I have an observer at a point two miles away who can never receive the station with sufficient volume to make it comfortable, yet other stations come in fine. Any kind of a receiver would fail to do any better, but because of its failure in one particular location it should not be condemned.

Again there are changing conditions, and perhaps these are the most misleading. We get station XYZ most any night for a

week or a month, and then can't get it again for a similar period. Why? The best scientists in the world are trying to find the answer.

One of the most earnest and conscientious of them is Dr. Greenleaf W. Pickard, of Newton, Mass. Dr. Pickard has made a study for years of how radio waves act and has published some exceedingly interesting and instructive results of his work. I cannot in this article go into a detailed

description of his work, but I would like to impress upon my readers the fact that Dr. Pickard has shown definitely that any transmitted radio signal only arrives at its destination (the receiver) after what might be called a distressing journey.

Dr. Pickard uses in his work a little instrument that draws a line that indicates just how and when the incoming signal varies in strength.

As the signal is strong and healthy, the little pen draws the line far up on the paper, and as the signal weakens, the pen draws the line farther down on the paper. From seconds to minutes or hours he is able to record in this way exactly how much the signal is capable of affecting the receiving set.

I think that most people would have more patience with radio and more respect for it if they could see these records being made, but I am fortunate enough to be able to show one or two typical examples of curves that were made in Dr. Pickard's laboratory. I have chosen two records shown in Fig. 4 and Fig. 5. Fig 4 is a record of reception from a "local" or nearby station and

(Continued on Page 52)

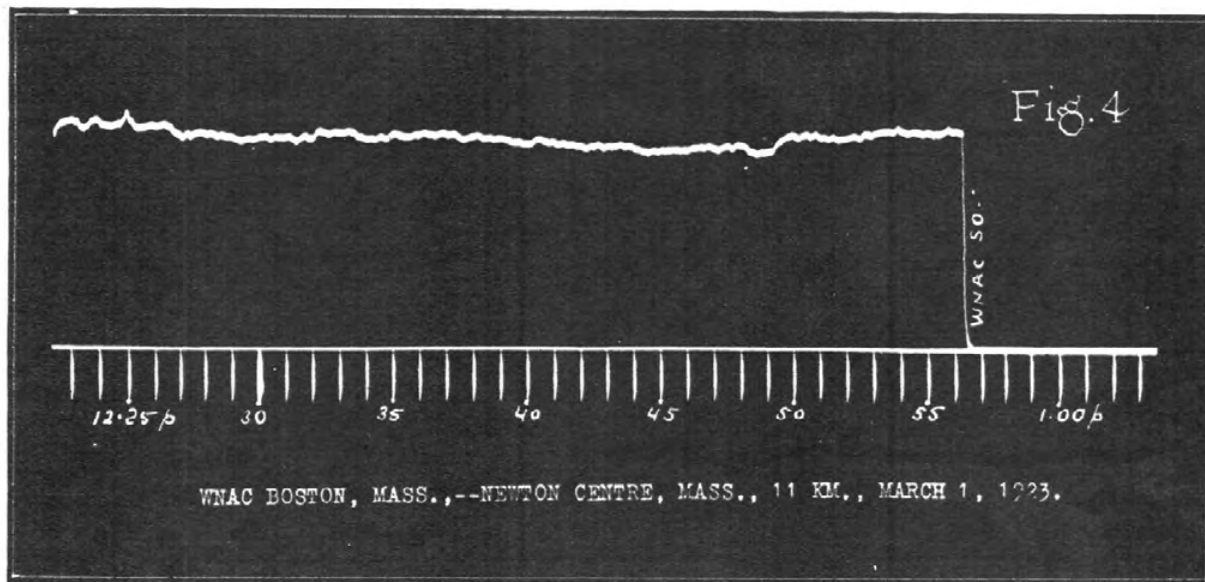
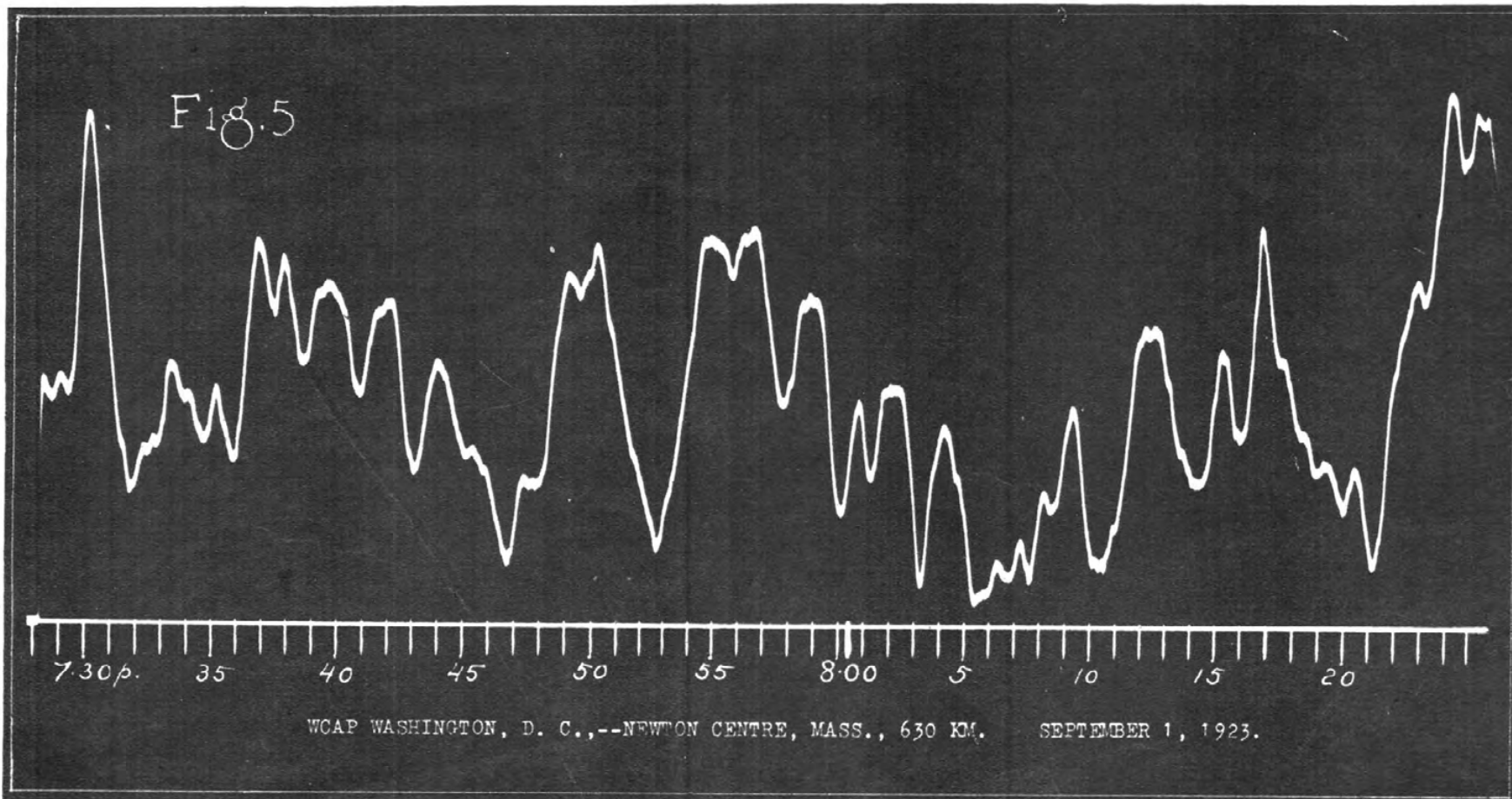

Figure 4—WNAC, Boston, Mass.—Newton Centre, Mass., 11KM, March 1, 1923



Figure 5—WCAP, Washington, D. C.—Newton Centre, Mass., 630 KM., September 1, 1923



# Can You Explain Radio to Your Friends?

By BRAINARD FOOTE

WHEN you've completed your very first receiving set and are just beginning to gain a glimmering of what's behind it all, you are almost always showered with bewildering queries by fond relatives and interested acquaintances. What's this for? What's that for? How does this work and why do you turn those knobs?

Of course you know perfectly well yourself that a movement of the dial tunes the grid circuit to the various wave lengths—but how to explain that to the uninitiated so as to satisfy them and yet without becoming involved in too complicated and deep a discussion?

You don't care to confess ignorance just to "get rid of them," but you scarcely feel able, perhaps, to furnish an elementary exposition of radio's principles that is elementary enough for one who knows nothing at all about it. Nevertheless, it is really not necessary for you to possess a full knowledge of radio theory yourself so you'll know it well enough to explain to others. It is merely necessary to deliver your explanation in terms with which your listener is familiar—relate your technicalities in some way to experiences and everyday matters with which they're already thoroughly conversant. It is not always the college professor, who is deeply versed in the entire array of details surrounding his subject, who is the best teacher. Often enough, the good instructor succeeds in putting his explanations over to his class by virtue of the fact that he has had to call on everyday experiences to explain them to himself.

In telling your friends about radio, you must, of course, gauge the fullness with which you treat each subject by the natural aptitude of your "pupil" for such matters. Your questioners range all the way from the excitable and faddy matron, who exclaims: "Isn't radio simply marvelous! I thrill when I think that the very air we breathe is vibrating with voices!" to the technically trained man who understands electricity and mechanics, but just hasn't encountered radio so far. The use of analogy is by far the most effective method of presentment. To liken the vacuum tube, by which the electric current through the loud speaker is controlled, to the valve controlling the flow of water through a water main, is, with some accompanying embellishment, to make the principle clear at once. And likewise, to state that the storage battery



Here's a radio outfit, sketchy, but workable nevertheless. The loud speaker and "B" battery at the right form the real music and speech-making equipment. The vacuum tube and its filament battery in the center are simply the medium whereby the radio currents coming in from the left are permitted to increase or reduce the strength of the "B" battery current and thereby cause the speaker's diaphragm to give off intelligible sound waves

for heating the filament of the vacuum tube, is just like the fire under the teakettle, is to explain something new and unknown in language of universal experience. The questions I am listing are common enough, and the answers to them are not intended as full technical explanations, but merely as general and easily comprehended instruction.

1. How is it that you can pick up music and speech right out of the air without anything connecting you with the broadcasting station?

Oh, but there is a connection, though it's invisible. You don't marvel because the sun's rays get here without a connecting medium that you can see, do you? You can't see light, nor feel it, but you can see and feel its effects. Without a surface for the light to fall on and other surfaces to reflect light, you'd never know it was there, and without the radio aerial and the radio set you'd never know there were

any voices and music coming your way.

The connection between us and the station is supposed to be a substance, or a gas, called "ether." Its particles are so tiny that they fill the "chinks" in everything else; they pour right through walls, stone and our bodies as water pours through a sieve. Light is nothing but an undulation of this ether: a series of little ruffles or waves in it, and so is radio. Radio waves and light waves are cousins: traveling with equal velocities, but different in the size of the waves.

2. What are the wires on the roof for?

They form the "aerial" or "antenna." The radio waves, in passing the aerial, set up an electric current in the wires just as the passing breeze turns the vanes of a windmill or as ripples on the pond make a cork bob up and down.

3. Why do you have this porcelain tubing under the window-sill and what is that brown affair outside with a wire leading down from it?

The tubing prevents any loss of current from the aerial wire. The amount of energy picked up by the aerial is so minute that there are no instruments sensitive enough to measure it. The slightest leakage through damp woodwork or walls might prevent us from hearing the station

at all. The outside instrument is a "lightning arrester." Not that it could actually stop lightning, but it allows small accumulations of electricity to discharge from the air over the aerial. There is a small air space in it and during thunder storms tiny sparks jump across in a continuous succession. The arrester in this way prevents the collection of a large and dangerous charge of electricity over the house that might result

in a lightning stroke. A house properly fitted with a radio aerial is much safer than one without. The arrester is like the safety valve on a steam engine—when the pressure gets too great, it leaks out through the safety.

4. What is the purpose of these knobs in front of the radio set?

Well, these three small dials control the electric current from a battery and vary the loudness of the reception. Notice how much fainter it gets if I turn one of them toward the "OFF" position. This other small one changes the sensitiveness and is useful in getting weak and far-off stations

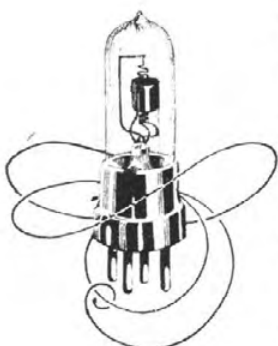

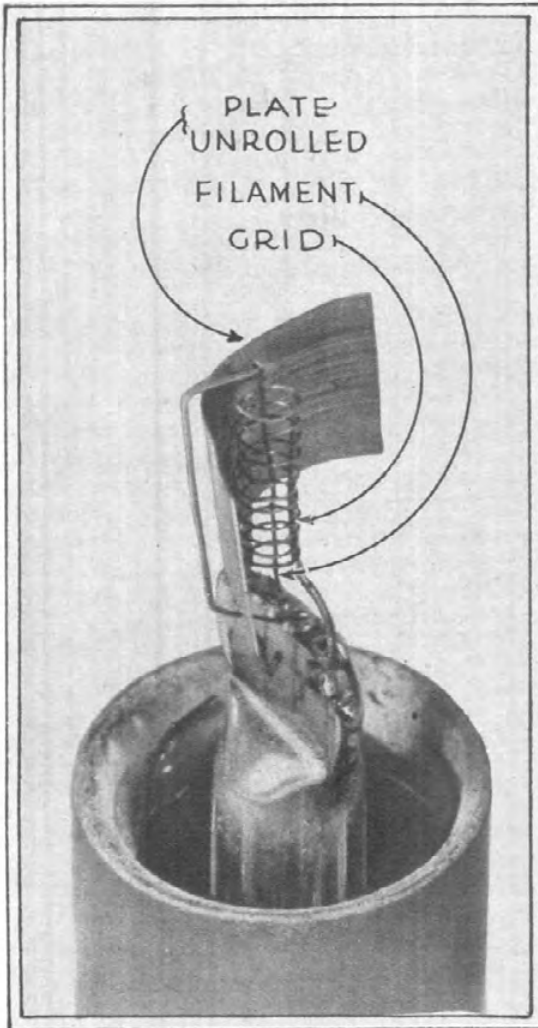

The radio vacuum tube is something like an electric light bulb. It has a filament that is lighted by a battery and two other special "elements"

(tickler and potentiometer). These larger dials enable us to pick out the one station we want and practically to shut out all others.

**5. How is the selection of the various stations accomplished? What is "tuning"?**

That's a hard one, but here goes! Take a violin, for instance. We have a string tuned to middle "C." At that pitch the string vibrates back and forth 256 times in a second and the pitch is said to have a frequency of "256 cycles" per second. If there is another violin nearby with a string similarly tuned and played upon, the middle C string of the first violin will also resound.

The sound waves in the air push and pull on the second string with precisely the correct frequency to set it going, just as water waves will cause a loose board in a pier to vibrate, providing the waves come in at the right intervals.

Now the string might be tuned in two ways. If the string is shortened

by pressing the finger upon it, the pitch of the note rises and we have a higher frequency. Should we exchange the string for another of similar length and tension, but of different thickness, the pitch would be different. A heavier string gives a lower note or lower frequency.

So with radio. Instead of a string we have a "tuned circuit" composed of a coil of copper wire and a bunch of interleaving metal plates in two separate groups called a "condenser." We can receive a longer wave length by using a good deal of wire on the coil (corresponding to changing the length of the violin string), or we may also receive a longer wave length by maintaining the length but increasing the "capacity" of the condenser (changing the string). The capacity of the condenser is increased by intermeshing more of its plates and the reason for the longer wave length is found in the fact that the electricity takes a longer time to travel around the circuit when there's a lot of wire and a lot of capacity.

**6. What is the difference between wave lengths and frequencies? I see both in the newspaper radio programs.**

The term "wave length" tells you the size of the waves and also where to set the dials for them, once you have learned how. Radio waves have definite spaces separating them, just like waves on the sea. Ocean waves might travel along the surface fifty feet apart—that is, with fifty feet intervening between the top of one wave and the top of the next one. WDAR, for instance, broadcasts on a wave length of 395 meters. In other words, the radio waves coming from WDAR's aerial are just 395 meters



Within the loud speaker we find a horse-shoe type of permanent magnet which pulls steadily and firmly on an iron disc (diaphragm) fastened just over it. The fluctuating "B" battery current pulses through copper wire wound over the two poles of the magnet and thus causes the diaphragm to vibrate. The sound waves it sends forth correspond to those which originally strike the transmitter at the broadcasting studio

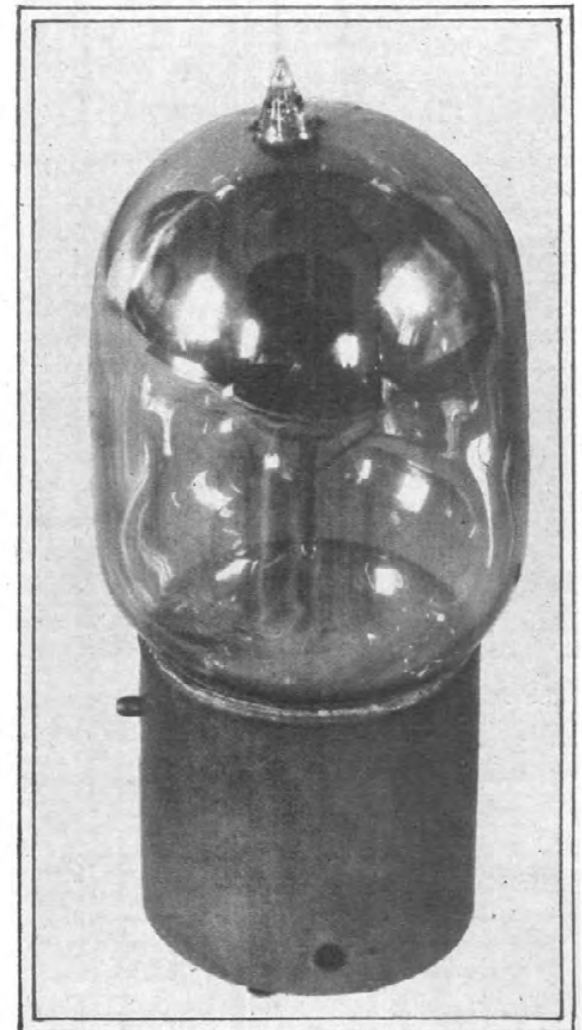

Removing the glass and opening things up we get a glimpse of the tube's elements. The filament, heated by current from the "A" battery, "boils off" electrons. These are pulled over to the plate by the action of the "B" battery, but their quantity is varied in accordance with radio impulses impinging on the "grid" or spiral wire between filament and plate

(about 1295 feet) apart. WEAJ uses 492 meters, or about 1610 feet for the wave length.

Suppose the ocean waves we've just mentioned roll along at a velocity of five miles per hour. That would be 440 feet a minute. Since they are fifty feet apart, there would be approximately nine waves landing on the beach every minute. That is the frequency: nine per minute.

Radio waves travel much faster, in fact, at a rate of 186,000 miles per second, or 300,000,000 meters a second. A wave like that of WDAR, 395 meters long, traveling along at 300,000,000 meters every second, has a frequency of about 76,000 cycles per second. In other words, 76,000 of WDAR'S radio

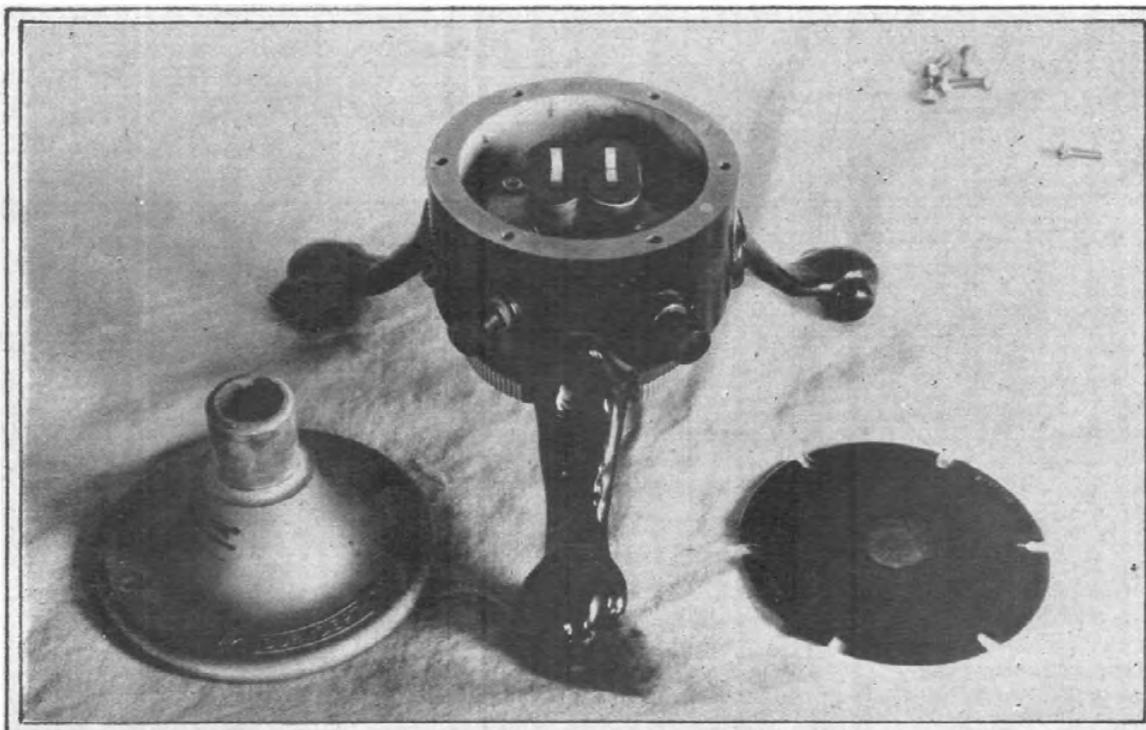

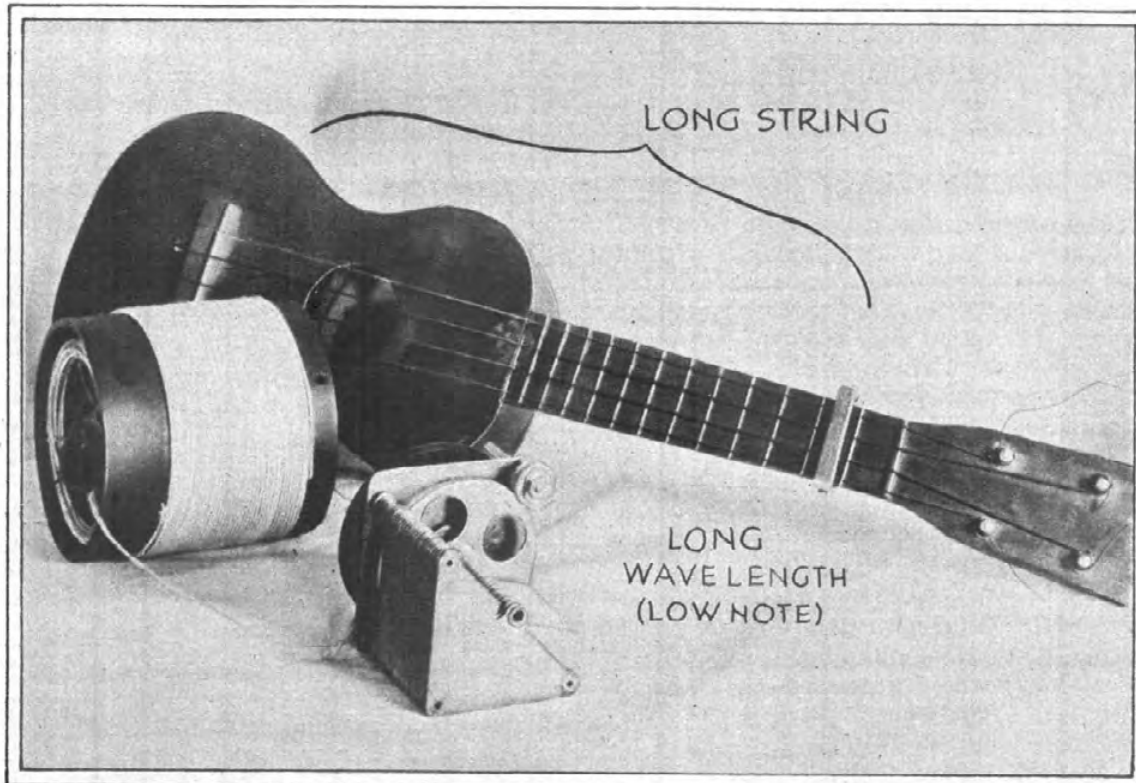

waves pass a given point in a second! Reminds you of the news comments on Fourth of July parades: "45,000 civilians marched by a given point in an hour." Frequency in radio is stated ordinarily in "kilocycles," 76,000 cycles is 76 kilocycles.

7. If the aerial gets so little power out of the air, how can the music be so loud on the horn?

The music and speech you actually hear is not the direct result of current flowing in the aerial wires. It is actually caused by current from batteries right here in back of the set—batteries called "B" batteries. They are made up of a large number of small cells such as you use in your flashlight. The electric pressure of the "B" batteries may be from 20 to 100 volts, depending upon the size of the battery.

A perfectly steady current would pass through the loud speaker and give no sound whatever were it not for those glass lamps you see inside the cabinet. By means of them, feeble impulses received on the aerial are enabled to turn the current from the "B" battery on and off in accordance with fluctuations in the sound waves of voice or music in the broadcasting studio. Before the glass lamp or "vacuum tube" can perform this seeming miracle, it must be lighted like any electric light bulb, a storage battery or dry battery being used for the purpose.

Thus, the radio set is nothing but a miniature power plant whose current to the loud speaker is automatically turned on and off by a special agency called a vacuum tube. In England they call the tube a "valve." Such it really is, for it controls the "B" battery current just as a valve in a water pipe controls the amount of water flowing in that pipe.

8. How does the vacuum tube operate?

Here we stumble onto "electrons," which are simply little specks of electricity whisking through a copper wire or lying dormant within a battery or even a piece of metal ready for use by the proper agency. When you heat water over a fire, some of the water vaporizes and "boils off" as steam. Likewise, when you heat certain metals, you "boil off" these electrons into space. Since the presence of air around the metal presses upon these electrons and

*Ever compared a ukulele with a radio circuit? In this case both are "tuned" for a low frequency (long wave length). If you could make the strings thicker the effect would be to make the wave still longer. Inter-meshing more of the variable condenser plates virtually does this*



*Here are the same two "musical instruments" adjusted for a shorter wave length (high frequency). In one case the change is made by shortening the strings and in the other by decreasing the interleaved section of the condenser*

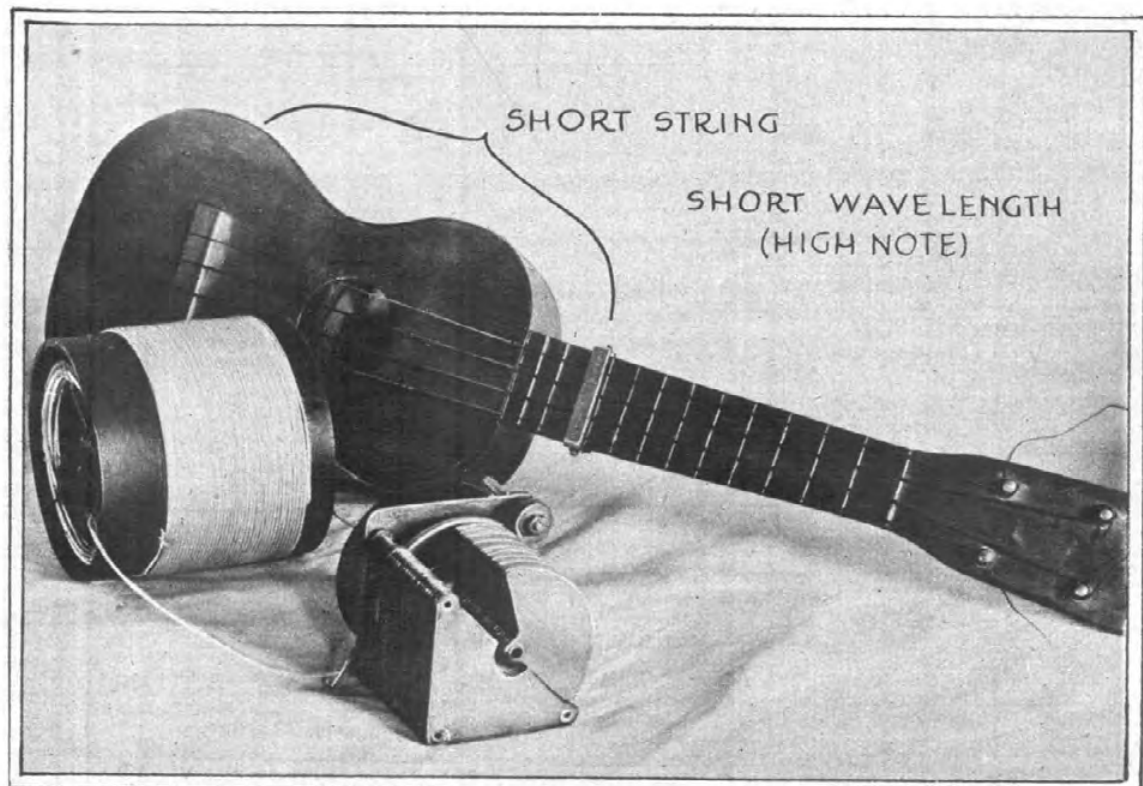

holds them inside to a great extent, the metal must be placed in a vacuum for best results. Water, you know, boils more easily at reduced air pressure and on Pike's Peak it's not easy to boil eggs because the water boils before it gets hot enough to do any good.

But without an electric current, it would be an impossibility to heat the metal white hot while it was in a vacuum. So the metal is formed into a thin thread called the "filament" and current from a dry or storage battery is sent through the filament to heat it. The hotter it gets, the more electrons are "boiled off." To utilize these electrons in a stream called an electric current, it is necessary to catch them on a piece of metal charged electrically to an opposite polarity. Electrons are negative. The other metal piece is a sheet of nickel, rolled into a cylinder and placed so as to surround, but not touch, the filament. This is termed the "plate" and is connected to the positive end of the "B" battery.

The electrons are attracted to the plate by the positive charge and a current is thereby set up through the head phones or loud speaker. This is a steady current, and its strength depends upon the voltage of the "B" battery and on the temperature of the filament. The temperature is regulated by a resisting device called a "rheostat" that controls the strength of the current from the storage or dry cell (the "A" battery).

In between the plate and filament we have a spiral of wire called the "grid," and through the wires of the grid the electrons must pass on their way to the plate. The aerial is connected, through the "tuning coils," etc., to this grid and its impulses charge the grid first negatively and then positively. When the grid has a positive charge of electricity, it scarcely changes the electronic flow from filament to plate, but when the grid is negative, it reduces the electron flow in almost exact proportion to the strength of that negative charge. Thus the weak impulses picked up by the aerial exert a powerful controlling effect upon the much greater "B" battery current through the loud speaker. By adding several of the tubes in a row, the effects are multiplied many hun-

(Continued on Page 36)

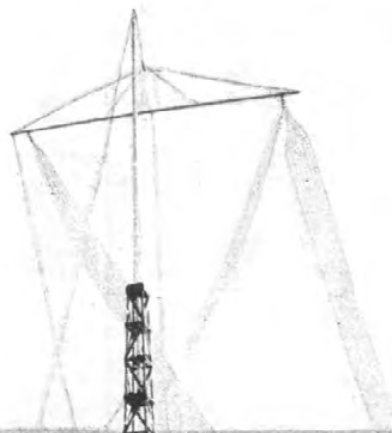

The little cottage on University avenue, Denver, which is the Radio in the Home of Dr. and Mrs. William Reynolds and Sonny, who operate KLZ. KLZ has an eighty-foot double cage aerial with counterpoise suspended about three feet above the house

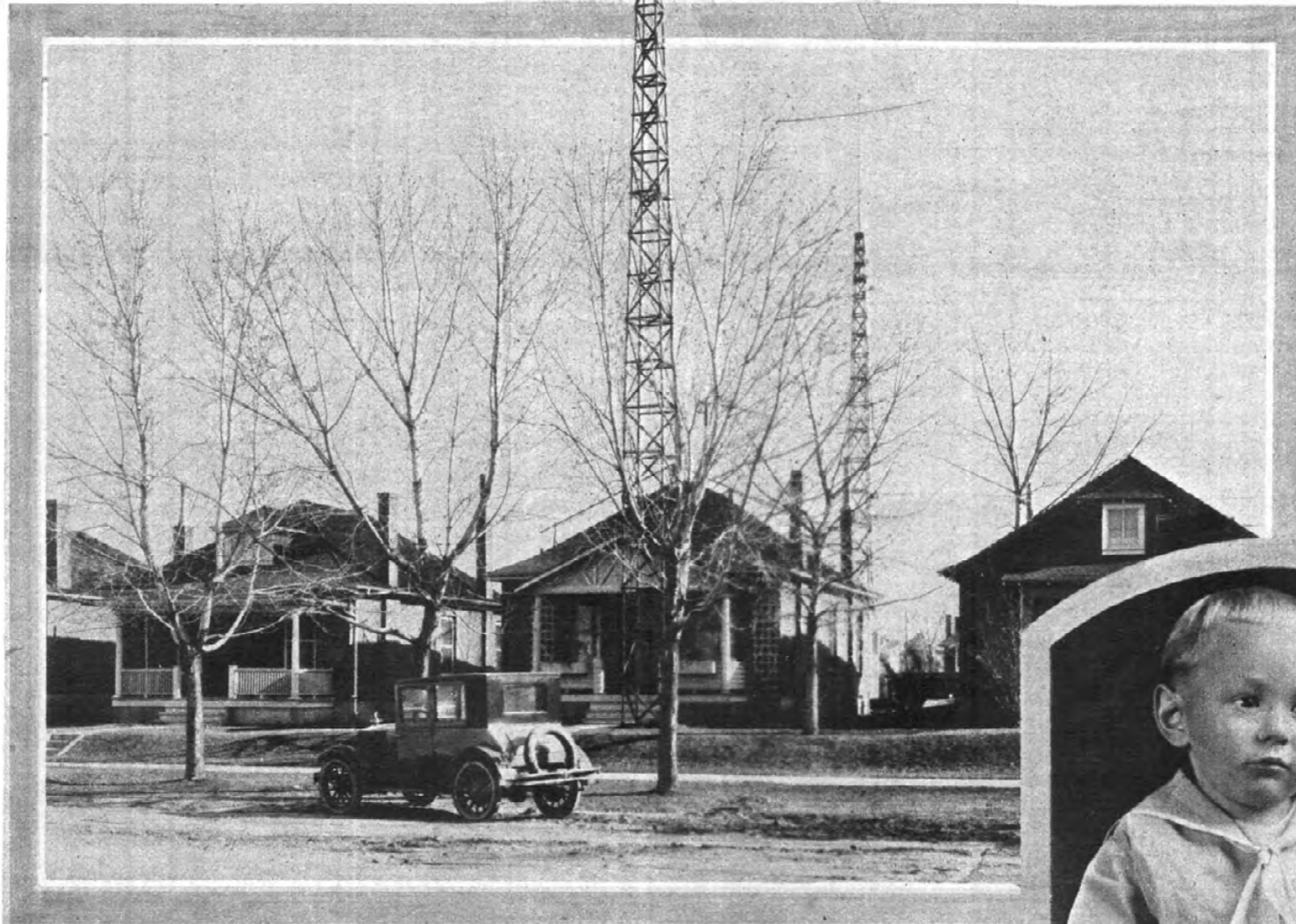

# KLZ is a Real Radio in the Home

By VERA BRADY SHIPMAN

AS I sat in the office of Dr. Reynolds in Denver recently I heard a small though powerful child voice coming through the receiving set in the outer room.

"Oh, that's Sonny, now," explained Dr. Reynolds, owner and director of KLZ. "That's KLZ Junior, telling some friends of his about his new rooster feathers."

I found Sonny to be a sturdy 4-year-old youngster whose radio activities were a part of his daily life routine. KLZ Junior is as well known within hearing of Denver radio as is Fitzpatrick's twang with the WDAF Night Hawks, or Uncle John of KHJ, Los Angeles. His real name is George William Reynolds, but the radio world knows him alternately as Sonny and KLZ Junior.

The pretty little cottage on University

avenue is the KLZ broadcasting station, operating on an average of 250 watts. Its distance records remarkably overshadow many of our 500-watt stations of less perfect climatic conditions.

Mrs. Reynolds is an accomplished pianist. Fans write in for certain piano numbers which they wish to hear again. The saxophone sextette, directed by Dr. Reynolds, is always welcome on the air, as are visiting artists who are glad to be entertained in the cottage with the antenna so much higher than its roof.

Mrs. Reynolds gives daily stock markets—and while some might call KLZ a one-man station, built and operated by Dr.

Here is George William Reynolds, otherwise known as Sonny and KLZ, Jr., age 4. He is the real "boss" of KLZ

Reynolds, the real broadcasters are the attractive wife and Sonny—who is always ready to go on the air and in his little, penetrating voice, tell the listeners just what is coming next from KLZ.

KLZ was one of the ten original licensed stations in the country and the first commercial broadcaster in Denver.

Dr. Reynolds came to Denver some years ago as a practising dentist, but radio grew too strong for his professional bent and transplanted its dental predecessor.

He is his own announcer, known on the air as "Doc" and frequently gives whole Reynolds family programs, playing the violin and saxophone with piano accompaniment and solos by Mrs. Reynolds and Sonny's able assistance with short-story telling. Concert and operatic visiting stars have appeared over KLZ from time to time.

The visitor sits comfortably in the arm chair in the living room enjoying the piano solos of Mrs. Reynolds, while in the adjoining room "Doc" and Sonny are at the microphone.

The simple operation of KLZ has become a tradition at one of the largest broadcasting stations in the East, where fifteen to twenty men are on duty during the broadcasting of a single program. Now and then, when these men ask for more help, they are told: "Just think of KLZ."

"The building and operation of a broadcasting station are difficult matters,"

Dr. Reynolds said, "There is very little written on the subject, and the details and difficulties in construction must be worked out from experiments before real results are obtained.

"One of the chief difficulties in operating is that of securing real talent.

"It is a comparatively simple matter to obtain jazz orchestras, but we have always tried to obtain at least one or two programs a week featuring classical

selections. We believe that the city's music societies and the Chamber of Commerce should co-operate in the effort to secure this higher grade of entertainment, and thereby benefit the entire city. This can be accomplished only by closer co-operation between public-spirited organizations and musical societies.

"One way in which the radio fans do their part to help improve broadcast pro-

grams is to send their appreciations to the entertainers personally, rather than in care of the station. Those who listen in should make it a point to take down the names and addresses of the artists and send at least postal cards direct to the entertainers, commenting on some part of the program.

"If more of this is not done, it will be still more difficult to obtain the best artists." During a recent Youth's Companion

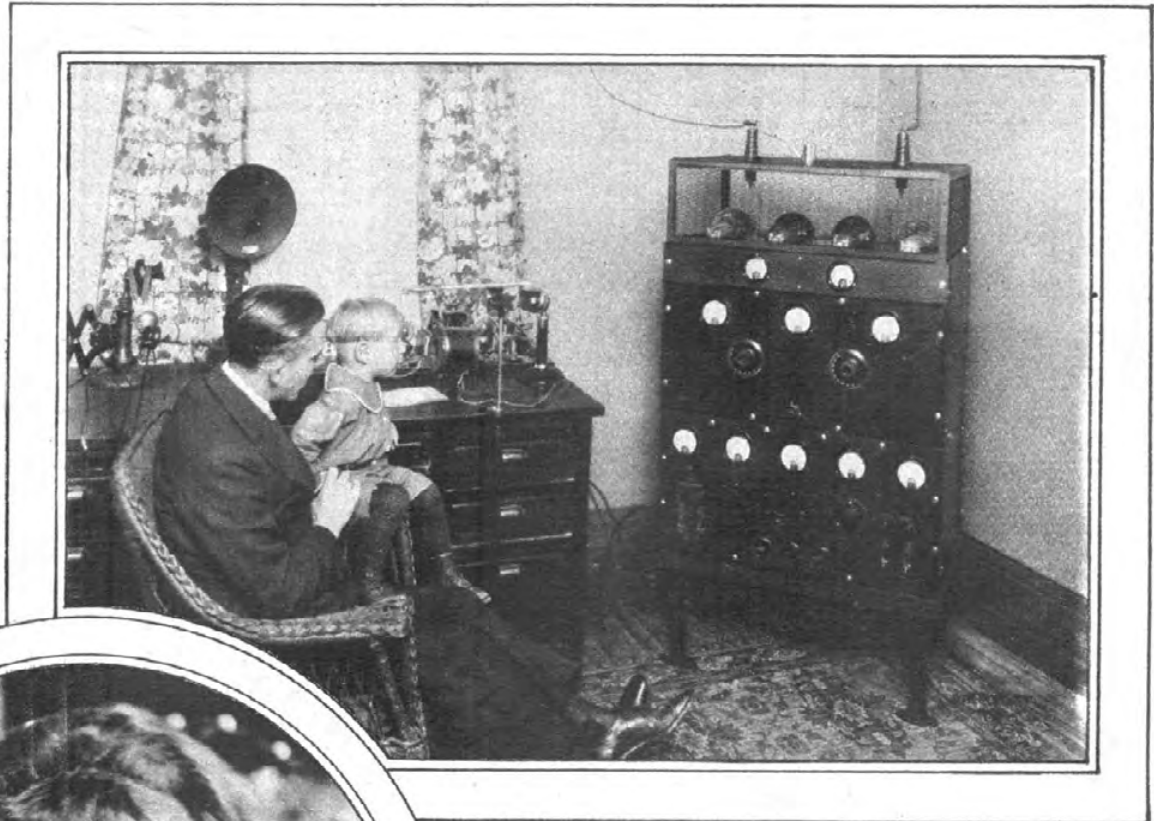

Above—"Doc" and Sonny Reynolds, announcers of KLZ, Denver



Circle—Mrs. Wm. D. Reynolds, the accomplished wife of KLZ owner, and a frequent broadcaster



radio week two fifteen-minute programs were given over KLZ in children's interest. The Denver Real Estate Board arranged weekly talks by Denver business men for Tuesday evenings over KLZ, doubling to Friday evenings as well, as their popularity increased. These attracted wide interest and gave extensive publicity to the Denver organization as the talks were on subjects of interest to the average radio listener, constructive and city building.

A Radio in the Home station you may call KLZ, with its home circle, the family broadcasting and the heart of the little child going out to the listeners in sympathetic appeal.

I am loath to leave when Sonny signs off, "This will be about all for now"—but there is no more until tomorrow.

Left—KLZ saxophone sextette. Left to right: Sidney Crooks, Lafe Boatman, Arthur Woolridge, Roland Wentworth, George Keyes and Dr. William D. Reynolds, director and organizer



**Actual  
Size  
Price \$35**

With Timmons Type  
R Special Rectifying  
Tube.  
Patented May 15, 1923

### Advantages of using a B-Limiter and your electric light current in place of B batteries—

It costs less than fifth of a cent per hour to operate a B-Limiter—much cheaper than using B batteries—you have an inexhaustible supply of B current.

The B-Limiter never wears out.

With a B-Limiter your B voltage is the same every night—there is no “drop” due to use. The B-Limiter has knobs for regulating both detector and amplifying voltage accurately, just as you do your filament voltages. This gives clear, crisp signals.

With a B-Limiter you cannot blow out a tube in case of crossed or mixed wires.



# Experts Praise Device Which Takes Place of B Batteries

The radio set owner who has looked forward to the time when he could simply plug in on his house lighting circuit (110 volt 60 cycle A. C.) and obtain the plate current for his set, doing away with B batteries, now has ample reason to purchase a B-Limiter with complete confidence in the results.

He has the endorsement of a great many thousands of B-Limiter owners plus the recommendation of experts who have tested B-Limiters even more exhaustively.

For instance, Captain Robert Scofield Wood, radio editor of the New York World, says in his paper, "The quality of the reception when using this B-Limiter as compared with new B batteries will be found much finer. The signals seem crisp and lifelike."

Andrew McLean Parker, radio expert and radio editor

of the Camden (N. J.) Post Telegram, says: "We are genuinely enthusiastic over this device."

Thomas Appleby, founder of the first Wireless School in America and President of Executive Radio Council, 3rd (United States) Radio District, said, "Reception was perfect when using a B-Limiter in connection with my five-tube set."

Just three of the enthusiastic endorsements.

But here you have enough proof to send you to the nearest good dealer for a B-Limiter. Take it home. Learn its operation—how both detector and amplifier plate voltages can be regulated to the fractional part of a volt. Find how convenient it is and how dependable. Ask your dealer for complete information on the Timmons B-Limiter and other Timmons Tested Products. If you prefer, write us direct for literature on all Timmons Products.

## TIMMONS RADIO PRODUCTS CORPORATION

GERMANTOWN



PHILADELPHIA

# B-Limiter

### Timmons Talkers



Type A—(Ad-  
justable)  
Price  
**\$35.00**

Type N—(Non-  
adjustable)  
Price  
**\$18.00**

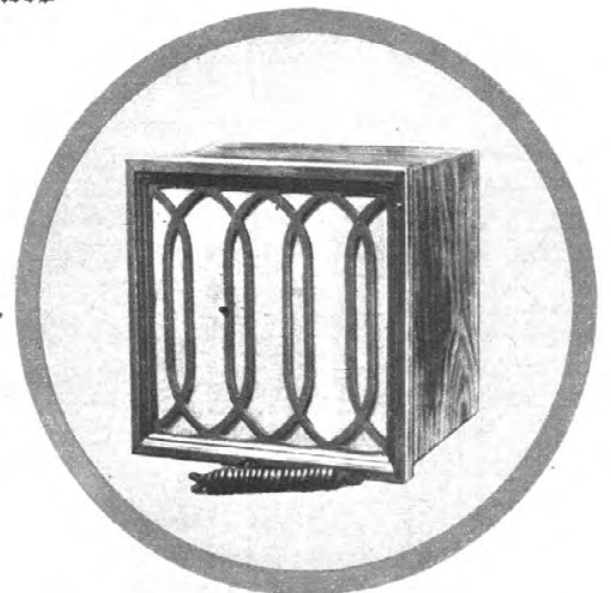

# Radio Brings Poetry to Home of Poetess



## RADIO

*Songs of children in the morning—  
ing—*

*Dust of camel trains at night—  
Gypsy vans—a moonlit garden—  
Flickering torch and acolyte—*

*Beauty comes from far-off places  
On my alien hearth to dwell,  
Looses here her winged sandals,  
Varying endlessly her spell;*

*Radio, opening wide my portals,  
Leads the starry guest within  
And I find each room grown spa-  
cious  
Where her wayward feet have  
been.*

*Clara Virginia Barton*

*"It is the call  
Of gray geese  
Flying south  
Beating the air  
With wings innumerable."*

THIS fragment of poetic thought, written by the housewife of this home, was symbolized in the painted geese above the open fireplace. And flying South they are indeed, reaching out their beautiful necks and wings in lengthy southerly flight as winter hovers all too near.

The home of Mr. and Mrs. F. S. Barton, in Salem, Oregon, is restful and artistic. It is as you or I would like it in our dreaming.

True radio lovers that they are, their Radiola Super-Eight is tuned in from Portland to Los Angeles, as the various announced programs attract, and frequently to far-distant

*Radio in the Home of F. S. Barton,  
Salem, Oregon. The set is a  
Radiola Super-Eight.*

stations across the mountain ranges of the country.

The poetic heart of Clara Virginia Barton (signing herself in poems and in radio writings as C. V. Barton) is often shown. The dream of little children, the conquest of far-distant music, the thrill of beauty in ether—these are epitomized in the simple verses of Mrs. Barton.

Around the fireplace and radio are the two Barton brothers with their wives and the small son of the younger brother. C. V. Barton stands beside the radiola.

*Radio in the Home*, indeed, in verses accompanied, what could more ideally signify the radio joy?

**8** improvements  
at **ONE** stroke

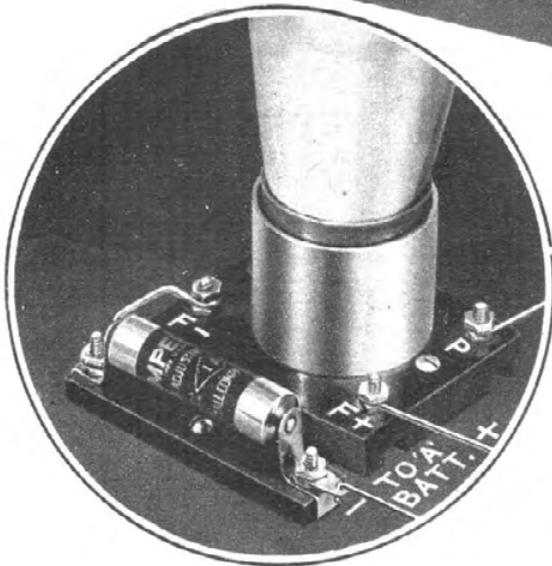
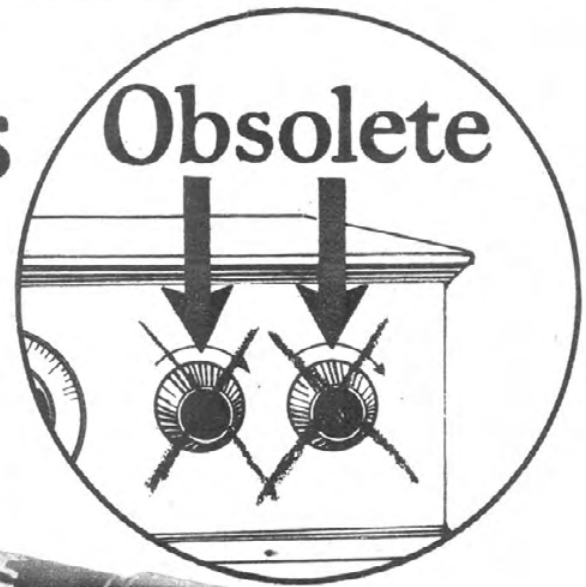

## The Self-Adjusting Rheostat

1. Eliminates hand rheostats—thereby simplifying control and giving compactness.
2. Greatly simplifies set wiring, therefore makes for greater efficiency.
3. Prolongs life of tubes from 2 to 3 times.
4. No moving parts—therefore no grinding noises.
5. Permits use of any type of tubes or any combination of tubes.
6. No filament meters necessary.
7. Brings the most out of each individual tube—automatically—no guessing.
8. Makes perfect tube operation absolutely fool-proof.

**AMPERITE** operates on the thermo-electric principle. Contains a specially treated filament hermetically sealed in a glass tube and surrounded by an inert gas. This filament has the unique property of automatically changing in resistance as the "A" battery voltage changes—so that a practically constant current is maintained in the tube filament. Consequently the tubes are constantly operated at maximum efficiency. No knob to turn. Nothing to get out of order. **AMPERITE** mounts conveniently inside the set. Really takes the place of a good hand rheostat, a delicate meter and an expert operator.

Thoroughly approved by every prominent laboratory. Used as standard equipment in such sets as Somerset, Ultradyne, Marshall, Pfanstiehl, Kilbourne & Clark, Heteroplex, Cockaday and numerous others. Perfect for every circuit. Fully guaranteed.

PRICE \$1.10 EVERYWHERE

Write for  
**FREE**  
Hook-Ups

RADIALL COMPANY, Dept. R.H.-4, 50 Franklin St., New York

# AMPERITE

REG. U.S. PAT. OFF.

*"means right amperes"*

LET the others have their card games—Grandpa settles down to real amusement—at the radio.

His dependable Brandes Headset shuts out the babble. Its *Matched Tone* gives him each word clearly—with identical tone and equal volume for both ears.

Grandpa's in a world of his own—and the game continues undisturbed. Everybody's happy!

Table-Talker \$10.00 (50 cents additional west of the Rockies.) In Canada \$12.50.

Superior Matched Tone Headset . . . . \$6.00. In Canada \$7.00.



# Brandes

The name to know in Radio

© Copyrighted by C. Brandes, Inc., 1925

## Can You Explain Radio to Your Friends?

(Continued From Page 28)

dred times, since the "B" battery current changes in the first tube act on the grid of the next tube and so on. You really listen to your "B" battery and not to the broadcasting station.

9. What's the purpose of this little flat battery in the cabinet?

That's a "C" battery and it acts on the grid together with the impulses from the aerial so as to keep the grid negative all the time. The impulses coming from the station merely make the grid more negative or less negative. Naturally, when the grid is negative, the "B" battery current is

usually caused by "static." This is atmospheric electricity, and is most prevalent in summertime. Sometimes such noises are caused by electric power wires or by passing trolley cars and electric trains, this only occurring when the aerial is very near the power wires.

11. What made Schenectady grow so faint just then?

That is "fading," a peculiar condition noticed at night and only on distant stations. The cause has not definitely been discovered as yet. Reception at night is much different than

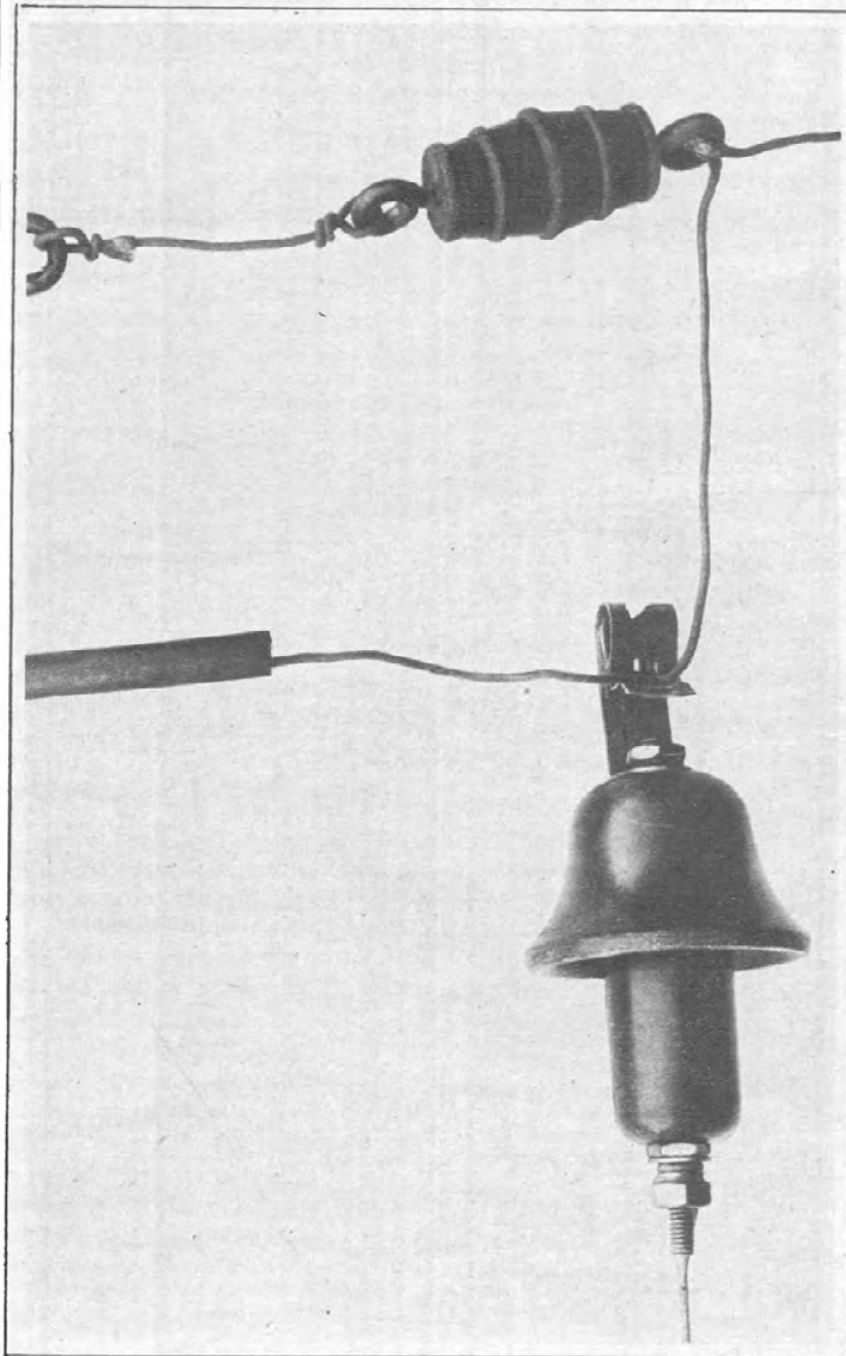

The aerial wire is passed through a porcelain or hard rubber tubing to prevent leakage through the woodwork of the window frame. The lightning arrester is placed outside, with a wire leading down to the water main.

cut down, and as a result the "B" battery lasts almost twice as long when the "C" battery is employed.

10. What causes those crackling and spitting noises we hear once in a while?

Noises come from many different causes. If I disconnected the aerial and we should still hear them, we'd know for a certainty that they were due to imperfect wire connections to the batteries, loose wires in the set, or defective apparatus somewhere. When the noises are only heard when the aerial is on the binding post, they are

in the daylight, for long distances can be covered with ease, when in the daytime, broadcast reception seldom goes over 200 miles at the outside.

12. Can you tell me what is inside of the loud speaker?

Yes. There is a magnet of considerable strength and a diaphragm or disc placed very close but not quite touching the magnet. This disc is always pulled down slightly by the magnets and is therefore always under a strain. Around the two poles of the magnet are wound several thousand turns of fine copper wire, through



# Build the 3-tube Counterflex with this complete Harkness Kit



The instantaneous and increasing popularity of the new Harkness Counterflex circuit is a good indication of its merits. Harkness fans all agree that it is the best yet—and the number of Harkness fans is increasing daily. Now Mr. Harkness has added the finishing touches to the 3-tube Counterflex circuit, simplified it a little, and made it just about the most worthwhile 3-tube circuit ever devised. This new, simplified 3-tube Counterflex receiver is very easy to build, especially if you use the complete set of parts contained in the genuine Harkness Counterflex Kit, illustrated on the left. The parts in this kit were designed by Mr. Harkness himself and are manufactured under his direct supervision. They are specially prepared to simplify the work of construction. The 7"x18" bakelite front panel is completely drilled and engraved. The three tube socket shells are securely fastened to a separate panel which mounts behind the front panel and beneath which are mounted the audio-frequency transformers. In fact, the parts in this kit are so arranged that, with only a screwdriver, you can put the set together in just a few moments. An instruction booklet, supplied with each kit, shows you how to assemble and wire the receiver. The illustrations in this booklet clearly depict each progressive step in the assembly and wiring, so that you can't possibly make a mistake.

**Harkness 3-tube Counterflex Kit . . . . . \$39.50**

This kit contains all the parts to build the commercial model of the new simplified 3-tube Harkness Counterflex Receiver as illustrated at the top of this page. Cabinet not included.

**Harkness 2-tube Reflex Kit . . . . . \$35.00**

This kit contains all the parts to build the famous 2-tube Harkness Reflex Receiver. This is the set which put efficient radio reception within the reach of all. The receiver is "self-neutralized," does not whistle or squeal and cannot cause interference to others. It has only two operating controls. Complete building instructions enclosed with each kit.

Try this new Harkness circuit. The kit is not expensive and is really quite a bargain when you consider the quality of the parts and the efficiency of the receiver you can build with them. Any other receiver with the volume, selectivity and receiving range of the Harkness Counterflex would cost you two or three times as much.

Ask your dealer for the genuine Harkness Counterflex Kit and look for Mr. Harkness' signature on the label. Avoid cheap imitations. If your dealer does not stock genuine Harkness products, send your order directly to us, giving your dealer's name and address.

# HARKNESS

DEPENDABLE RADIO PRODUCTS

Manufactured by  
**KENNETH HARKNESS RADIO CORPORATION**  
 727-739 Frelinghuysen Avenue, Newark, N. J.  
 KENNETH HARKNESS  
 President

## Mail this Coupon for Illustrated Book

Kenneth Harkness Radio Corporation,  
 727-739 Frelinghuysen Avenue,  
 Newark, N. J.

RIH 1-25

Please send me a copy of your illustrated booklet describing the commercial model of the new, simplified 3-tube Harkness Counterflex receiver with detailed building instructions and step-by-step wiring diagrams. I inclose 25 cents to cover cost of handling and mailing.

Name .....

Address .....



## Each Instrument in PERFECT TUNE

Here is the test of a loud speaker. Tune in a great orchestra. Do you hear a grand ensemble in perfect harmony? Or—do the upper tones of the violins, the flutes, the oboes and the clarinets come in a trifle "flat"?

The Bristol Audiophone brings in voice or instrument in perfect tune, just as it sounds in the studio. This is because it is itself a true musical instrument; not merely a phone unit in a horn. You will love your Audiophone as you would love a fine violin.

There are five Bristol Audiophones, priced from \$12.50 to \$30.00. If not at your dealer's, write for Bulletins No. 3011, 3017, and 3022-Q.

**THE BRISTOL COMPANY**  
Waterbury, Conn.

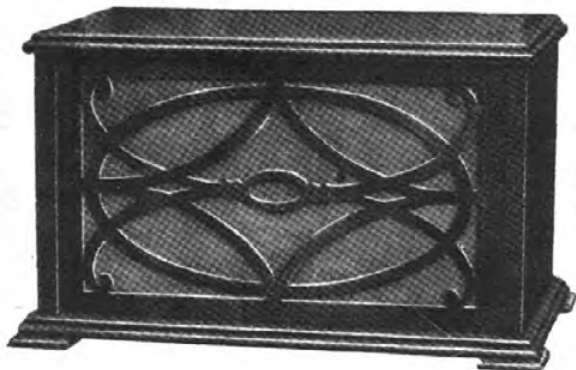

**Cabinet Model**  
\$30.00

Beautifully finished mahogany. Full floating wooden horn and cast metal throat. Musically, a companion to the finest set ever built. Size 17x10x10 1/4".

# BRISTOL

TRADE MARK  
REG. U. S. PAT. OFFICE

## AUDIOPHONE

# LOUD SPEAKER



**Model S Audiophone**  
\$25.00

Rubber horn 14 1/2" in diameter. Cast metal throat. Velvet mat finish of mottled bronze and gold.

which the "B" battery current courses. It aids the strength of the magnet at times and thus pulls more strongly on the disc. Since the vibrations of this diaphragm are in accordance with those of the transmitting station, the diaphragm sets up sound waves in the form of voice or music. Some loud speakers have an adjustment whereby the magnets may be moved close to the diaphragm for weak stations and away from it for strong ones. If the magnets are too close for a loud station, they are struck by the diaphragm and a rattle results.

13. I notice that your list states that you get WGN at 33. Bill gets the same station at 48. How is that?

The dial number doesn't really mean anything. It's just a reference indicator to help you in getting the same station time after time. Dials are standardized and may be attached to tuning instruments of many different types. You merely note down the number at which a certain station is heard in order to know the next time you want that station where to find it.

### Grimes' Final 3XP

(Continued From Page 15)

done. They have arranged the circuits to overcome feedback of all sorts. You have already had experience in the September article on the Hazeltine system; and many readers found that with careful construction they could remove the neutrons altogether. So let's not worry about the feedback in the tube if the other difficulties have been removed. Be sure and mount your radio coils fairly far apart and at right angles to each other—on the same line of centers.

So, then, we find ourselves back to the Grimes 3XP system shown in the June and July issues—with certain improvements desirable to make it more universal and foolproof. It is becoming more and more apparent that no one design of set can possibly meet all receiving conditions unless switching arrangements are incorporated in the set. This we have done and at the same time are using a hard detector tube with a circuit for dispensing with the detector "B" battery entirely. How's that for simplicity? The stunt described in last month's issue is also shown as it entirely overcomes hand capacity and "hum" on the middle dial.

By referring to the diagram the various changes will be readily seen and appreciated. This is a four-tube set so arranged with the Inverse Duplex principle as to produce two stages of tuned radio frequency, a tuned detector and three audio stages of amplification. It has all of the earmarks of the 3XP set because that's exactly what it is. Those of you who build that set-up can very easily convert it into this final model and those of you who didn't build it will find this set a very easy one to construct.

Probably the most startling change to you will be the detector tube circuit. It may not be new to some of you for it is not original with us. It is a perfectly obvious arrangement when one thoroughly understands the theory of vacuum tube operations. By connecting the grid of the detector to minus "A" and the plate circuit to plus "A," we really have about three volts on the plate and under this condition, a hard tube will act as a very good and sensitive detector. A detector "B" battery is thus dispensed with altogether.

Another advantage in this arrangement is the elimination of the grid leak and condenser. This saves some expense but primarily makes the receiver much more stable. The grid of a detector tube employing a grid condenser and leak is very sensitive to stray audio energies. It is often

referred to as a "floating grid." It will pick up and feed back very minute audio currents. It has a great tendency to howl with three audio stages.

When using this idea, it should be noticed that "reversed phase" on the primary of the first audio transformer is desirable. This reduces overloading on local reception. The phase is reversed by merely connecting the plate of the detector tube to the "B" terminal of the primary and the "P" terminal is fastened to the plus filament of the tube. There is only one disadvantage in this scheme of "batteryless" detector—it chokes up on very loud local reception, but such conditions have been found to be very rare. The many advantages greatly outweigh this one handicap.

More words will not be out of place in this article on the connections to the secondary of the first audio transformer. Experience has proved that the old method of connecting the grid circuit of the first audio in the original Grimes 3XP often produced a bad hand capacity effect on the middle dial. The cause for this was the fact that the tuning condenser in this circuit was connected to the grid of the first audio stage, which, of course, picked up and amplified any stray audio fields caused by the hand of the operator. This forced the interchanging of the radio and audio transformers in the grid of this tube so that the radio tuning condensers would be located on the ground side and not the grid side of the first audio transformer.

It always appears in development work, that nothing is gained without some sacrifice. This change was no exception to the rule. Placing the audio transformer in the "high" side of the radio circuit inserts a fixed capacity to ground through the windings of the audio transformer. This causes the tuning condenser to run lower than normal. To help remedy this, remove about four turns from the secondary of this second radio transformer.

The design of the three radio transformers will now be as follows:

Coil A	{ 16 Primary—tapped every two turns
	56 Secondary
Coil B	{ 8 Primary
	52 Secondary
Coil C	{ 8 Primary
	56 Secondary

These are the specifications when used with 23-plate tuning condensers. Of course, the secondaries are honeycomb coils cut down from some of the standard makes, such as sixty-two or seventy-five turns. The primaries you will easily be able to wind on with about No. 24 double cotton-covered wire. This size is not important.

The final change is the installation of the "super-volume" switch. This has been done with the idea of making the set more universal in its operation. There are many locations where excessive amplification is not required nor desired. Furthermore, some experimenters like to use head phones and do not want three audio stages for such work. Reception from local stations very rarely needs the additional audio. So the double pole, double throw jack switch has been installed.

This switching arrangement merely cuts out the middle audio amplification stage—causing the first tube to function as a pure radio-frequency tube. It is this tube that overloads first on strong signals and, for this reason, it was chosen as the tube to relieve by such a switching circuit. This will give a marked cut in volume, but gradual intermediate steps may be had by the taps on the aerial coil, the filament rheostat and by detuning. All of these combinations make it a most universal set.

We are giving below a few suggestions that we know will insult your

# Tone Clarity

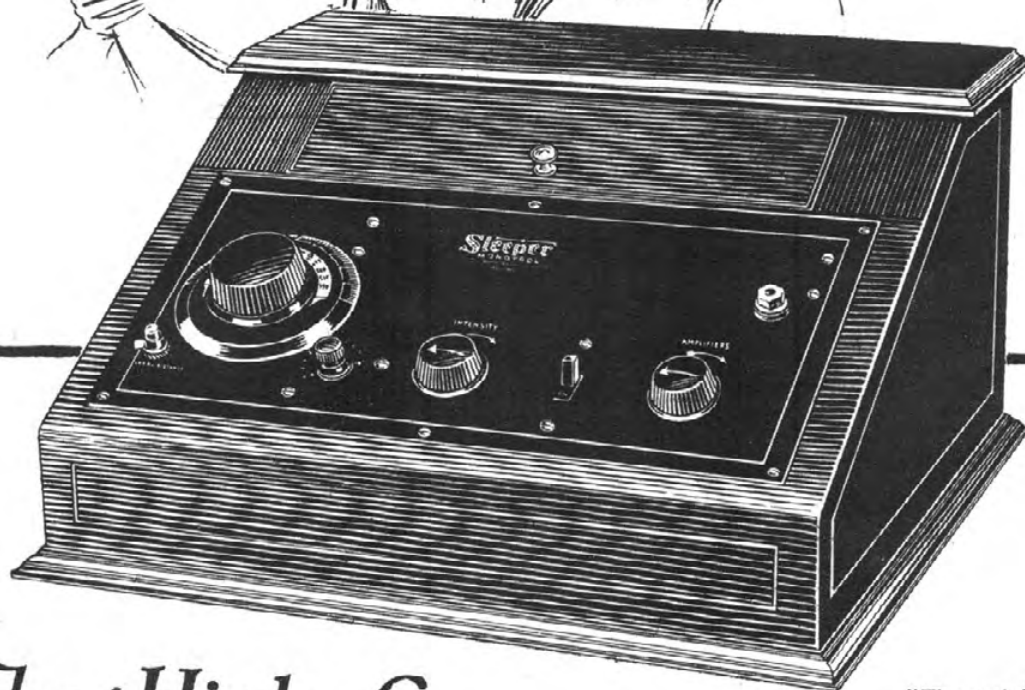

## The High C of a Soprano The Low C of a Bass

*"They copied all they could follow.  
But they couldn't copy my mind.  
And I left 'em sweating and stealing  
A year and a half behind."  
—KIPLING*

THE high "C" of a soprano—the low "C" of a bass—the clear treble of a piano...the rumble of an organ... try the Sleeper Monotrol's ability to reproduce all kinds of tones under all kinds of conditions.

On performance is the best way to buy the Sleeper Monotrol. Demonstrated performance. You can see its beauty, its compactness. Try it for distance—volume, selectivity, ease of operation—and for Clarity of Tone.

For those who are technically minded, the reason for the surprising tone clarity of the Sleeper is this: The Inverse Duplex circuit makes the four Sleeper tubes

do double duty. The Sleeper Monotrol, because of this circuit, has three stages of tuned radio Frequency Amplification and three stages of Audio Amplification, usually possible only with Seven Tube Sets. The elimination of the three extra tubes including the noisy detector making for far greater purity of tone.

Another reason for the Sleeper Tone Clarity is the method of mounting the tubes so that shocks and jars are absorbed by the mounting and are not transmitted to the tubes and amplified into squeals and shrieks. Any Sleeper dealer will gladly demonstrate a Sleeper Monotrol your way. The time payment plan can be used if you so desire. A copy of the free booklet "How to Choose a Radio Set" is yours upon request.

SLEEPER RADIO CORPORATION, 500 Washington Ave., Long Island City, N. Y.

Licensed under Grimes Inverse Duplex Patents No. 1,517,057-8 and Hogan Patent No. 1,014,002.

# Sleeper MONOTROL

The Sleeper Monotrol without accessories is priced at \$130



REG. U.S. PAT. OFF.

### It's Compact



**OTHER RADION PRODUCTS**

The same qualities of low-loss insulation and attractive appearance characterize Radion dials (to match panel), binding post panels, insulators, knobs, etc.—also new Radion built-in horn.

**Surface leakage exceptionally low with this panel—built to order for radio**

THE needs of radio are SPECIAL. Better results have invariably followed the use of apparatus and materials designed for its own unique demands.

Radion is a special material, developed to order by our engineers to meet the needs of radio. For radio-frequency insulation its characteristics are highest as proved conclusively by authoritative laboratory tests. Surface leakage and dielectric absorption are shown to be exceptionally low.

*You can see the difference by the finish*

YOU can see that Radion is different if you look at the finish. That high-polished, satin-like surface is not only good-looking, but useful as well. Moisture and dirt cannot gather to form leakage paths and cause leakage noise.

Radion is mechanically right, too. It resists warping. No special tools are needed to make a clean-cut workman-

like job. Everybody knows that it is the easiest material to cut, saw or drill. Comes in eighteen stock sizes, two kinds—black and mahogany.

Better performance will make it worth your while to ask for Radion by name, and to look for the name on the envelope and the stamp on the panel. Radio dealers have the exact size you want for your set.

Send 10 cents for new booklet, "Building Your Own Set." Use the coupon below.

AMERICAN HARD RUBBER COMPANY  
Dept. N 2, 11 Mercer St., New York City  
Chicago Office: Conway Building  
Pacific Coast Agent: Goodyear Rubber Company  
San Francisco — Portland

**RADION**  
*The Supreme Insulation*  
**PANELS**

Dials, Sockets, Binding Post Panels, etc.

AMERICAN HARD RUBBER COMPANY,  
Dept. N-2, 11 Mercer Street, New York City.

I enclose 10 cents for which send me your new booklet, "Building Your Own Set," giving wiring diagrams, front and rear views, showing a new set with slanting panel, lists of parts for building the most popular circuits, etc.

Name .....

Address .....

intelligence, but here goes, anyway.

1. Use good new "B" batteries. Test for loose connections in your "B" batteries. They should be absolutely quiet.

2. Be sure to have good contact in your tube sockets. Bend up the contact springs if necessary.

3. Try reversing the connections of your loud speaker. Most of them are built to work better one way than the other. The best "polarity" will also increase the life of your speaker.

4. Be sure that the tubes used in the radio stages are in good condition. Radio amplification requires a good tube. Audio amplification isn't so particular. Try interchanging the tubes about in the sockets and try an extra one to determine best amplification condition. The mere fact that a tube lights is no indication of its being a good amplifier.

5. If you are located near a large local station, always reduce your coupling taps to the aerial for best results. Don't try to overload your set. It only spoils the quality and produces an overload howl.

6. Mount your tubes on rubber if possible and place the set in a box provided with a lid. Otherwise you may experience a microphonic howl building up between the loud speaker and the tubes. A loose element in one of the tubes is the cause of this. If this particular tube happens to be inserted as the first audio tube, this trouble often develops. Try changing such a tube to the last audio stage. A microphonic howl is readily noticed and recognized by the fact that it gradually builds up into a roar and it may be stopped by stuffing up the horn of the speaker.

The above suggestions apply to any kind of circuit and are often the causes of failure when attempting something new. Under these conditions, the trouble is ignorantly blamed on the new hook-up. We have listed the above in self-defense, even though it hurts your dignity.

Until we have more letters outlining the results of the change in the connections of the first audio transformer, we will not be in position to go into this subject thoroughly. Last month's issue first described the reasons for the change, and we are incorporating this change in the final 3XP set. This change will stand on the books in future adaptations of the inverse duplex until further improved.

Here's wishing you further luck on this combination, realizing, meanwhile, that we are all developing into experts on the inverse duplex and its adaptations to modern radio circuits.

We have well under way in the laboratory the inverse duplex superheterodyne, and it certainly looks promising. The last problem now involved is to prevent radiation from the set. When this is done we will present it to you—next month, we hope! Mind; that isn't a promise. It's only a hope.

Here are the usual check-up lists for the 3XP-style wire-ups:

- Diagram Number 1—List of Parts**
- 1-2-3-4—Tube sockets.
  - 5—Micadon fixed condenser .001.
  - 6—56 turn honeycomb coil with primary of 16 turns on the outside, tapped every 2 turns.
  - 7—Micadon fixed condenser .002.
  - 8—Honeycomb coil of 52 turns with primary of 8 turns.
  - 9—Micadon fixed condenser .002.
  - 10—Honeycomb coil of 56 turns with 8 turns for primary.
  - 11—Audio transformer, 3 to 1 ratio.
  - 12—.0005 variable condenser.
  - 13—Audio transformer, ratio 3 to 1.
  - 14—.0005 variable condenser.
  - 15—Audio transformer, ratio 3 to 1.
- From the filament to the grid posts of this transformer you should mount a fixed condenser of .0005 and from

the B to the P binding posts you should mount a micadon fixed condenser of .001.

16—.0005 variable condenser.  
17—Back mounted tap switch of at least 7 points.

18—Rheostats from 6 to 10 ohm.  
19—Double pole, double throw switch jack — Carter, Yaxley or Marco.

Seven binding posts will be needed as shown at the back of the baseboard. We do not use a jack for horn or phones, but attach the horn permanently to the binding post. The double pole, double throw switch, number 19, enables us to cut out one step of audio-frequency amplification in case we want to use phones there. These binding posts, as is shown here, reading from left to right, are, first pair, aerial and ground; between first two sockets minus A; between second and third sockets one binding post, to which is attached both plus A and the minus B wire; between sockets three and four a binding post for the 90-volt positive B (remember we do not use any detector B on this); to the right two binding posts for the horn. If you are likely to use phones much, it will be better to substitute an open circuit jack for these binding posts and bring the jack front to mount on panel.

**Diagram Number 2.**

From minus filament binding post directly to one side of rheostat number 18.

Connect all of the minus binding posts on the tube sockets together by one wire running the entire length.

From the other side of rheostat number 18 to any point on this common wire.

From the outside wire of honeycomb coil number 8 to any point on the common filament wire.

From filament binding post of transformer number 13 to any point on the wire leading from the minus A binding post to the rheostat.

From filament binding post of transformer number 11 to any point on the wire from minus A binding post to rheostat, the same wire to which we have just soldered.

From terminal number 4 or the fourth terminal from the bottom of jack switch number 19 to any point on the common wire connecting the filaments of the sockets.

From one side of the fixed condenser number 5 to minus filament binding post of socket number 1.

**Diagram Number 3.**

**Positive Filaments.**

Run a long wire beginning at the ground binding post and looping around the positive filament connections of all four sockets.

From the binding post marked positive A and negative B run a wire directly to the nearest point on this common wire and solder.

From the last turn of the primary winding around honeycomb coil number 8 run a wire over to the common wire and solder.

From the last turn of the primary winding around honeycomb number 10 run a wire over to the common bus wire and solder.

From the plate connection of transformer number 15 run a wire over to the common bus wire and solder. Be sure that you have first connected your .001 fixed condenser from plate to B on this transformer before you run this wire.

**Diagram Number 4.**

From the plate connection of socket number 1 to one side of fixed condenser number 7.

From the other side of fixed condenser number 7 to the beginning of primary around honeycomb coil number 8.

From plate connection of socket number 1 run a wire behind all of the



sockets to the plate binding post of the transformer number 11. This is typical of the places where it pays you to use our favorite Celatsite wire, because as this wire runs under both A and B binding posts, it requires good insulation to be sure that there will not be a short circuit.

From plate connection of socket number 2 to one side of fixed condenser number 9.

From the other side of fixed condenser number 9 to the beginning of the primary winding of honeycomb coil No. 10.

From plate connection of socket number 2 run a wire over to plate connection on transformer number 13. It probably will be more convenient to run this wire directly over fixed condenser number 7, but we do not show it that way in the drawing because it would make the drawing confusing.

From the plate connection of socket number 3 to B connection on transformer number 15. Here again let me warn you to be sure you have attached the condenser across those two binding posts of the transformer first.

From plate connection of socket number 4 to the right hand binding post for the loud speaker (or top blade of jack, if you use jack).

From the other binding post for loud speaker (or jack) run a wire behind socket number 4 over to the 90-volt B battery binding post. From that same loud speaker binding post run a wire to the B binding post of transformer number 11.

From the B battery binding post of transformer number 11 to the B battery binding post of transformer number 13.

**Diagram Number 5  
Grid Connections**

From the grid connection of socket number 1 to the inside winding of honeycomb coil number 6.

From outside winding of honeycomb coil number 6 to one side of fixed condenser number 5.

From the same side of fixed condenser number 5 run a wire over to connection number 5 on jack switch number 19. (Please remember in our numbering of these connections of the jack switch that we count from the bottom.) This wire may be run underneath the variable condensers as shown, and it is best to keep it as far away from other wires as possible.

From grid connection of socket number 2 to grid connection of audio transformer number 15. Be sure that you have first attached the .0005 condenser across the secondary of this transformer.

From filament connection of transformer number 15 to the inside winding of honeycomb coil number 8.

From grid connection of socket number 3 to inside turn of honeycomb coil number 10.

From the outside winding of honeycomb coil number 10 to negative binding post.

From grid connection of socket number 4 to number 2 blade of jack switch number 19.

Blade number 1 and blade number 6 of jack switch number 19 are connected by a wire.

Run a wire from this common wire between blade 1 and 6 over to grid connection of transformer number 13.

From grid connection of transformer number 11 to blade 3 of jack switch number 19.

**Diagram Number 6  
Condensers and Tap Switch**

From aerial binding post to the beginning of primary winding around honeycomb coil number 6.

From blade or shaft of tap switch number 17 to ground binding post.

Wire up the tops on the primary around honeycomb coil number 6 to

W O R K R I T E R A D I O S E T S W O R K R I G H T

The WorkRite  
**CHUM**  
\$75



**A 3-Tube Neutrodyne That  
Out-performs Most 4-Tube Sets**

HERE'S a brand new 3-tube reflexed Neutrodyne—one that sells for a remarkably low price. You have never seen a 4-tube set—even one that costs many dollars more—that could beat it.

The WorkRite Chum has a remarkable range. Distant stations—fully a thousand miles away—come in clearly and distinctly on the loud speaker. Under favorable conditions the Chum will cover a much larger area—and without whistles, howls or distortion to spoil your fun.

It has selectivity, too. Tunes out local stations and brings in others clearly and sweetly as can be.

This beautifully built set is self-contained. There is space in the handsome dark mahogany cabinet for both A and B dry batteries. It works with any kind of an aerial—outdoor or indoor—and is always ready for instant use—any time or any place.

You must hear the Chum or any of the other famous WorkRite sets to appreciate real radio reception. Sit at the dials yourself. Get the real thrill of radio from WorkRite. Any WorkRite dealer will gladly let you demonstrate any of these famous sets to your own satisfaction. If the dealer you visit hasn't WorkRite in stock, send us the coupon today for complete information.

THE WORKRITE MANUFACTURING COMPANY  
1808 EAST 30TH STREET CLEVELAND, OHIO  
Branches: Chicago, 536 Lake Shore Drive; Los Angeles, 239 South Los Angeles Street

**WORKRITE ARISTOCRAT**  
A 5-tube Neutrodyne Set

In this beautiful mahogany console, the loud speaker is placed on one side and compartment for A and B batteries on other side. All connections made inside with cable and plug. A set unsurpassed in any respect. Price, without accessories . . . . \$350.



Send Coupon for FREE  
Rotogravure Booklet

The WorkRite Manufacturing Co.  
1808 East 30th Street Cleveland, Ohio  
Please send me FREE a copy of the  
Rotogravure booklet which describes  
WorkRite.  
Name .....  
Address .....  
City ..... State .....



**WORKRITE RADIO KING**  
A 5-tube Neutrodyne Set

Encased in genuine brown mahogany cabinet with graceful sloping panel. Distortionless loud speaker built into cabinet behind handsome grille. WorkRite Air Master is almost identical with Radio King except it has no loud speaker.

Prices:  
Radio King, without accessories . . \$220  
Air Master, without accessories . . \$160

**WORKRITE**  
**SUPER NEUTRODYNE RADIO SETS**

**SUPER-HETERODYNE**

Many people write us to ask us why we don't print the hook-up for a good super-heterodyne. The answer is easy. In our issue of March, 1924, we gave full details for building a super-heterodyne which gives the best quality of any we have used. We have not since run across a super that was any better.

**Are You a "Super"-Fan?** —Then get this article and build the set. It's just as good today as the day we printed it.

Full Details. Complete Instructions. Photographs of Layout. Schematic Diagram. "Picture" Diagram. Everything complete so that even a novice can build it. Send 10 cents for the March, 1924, issue.

Circulation Department **RADIO IN THE HOME** 608 Chestnut St., Philadelphia

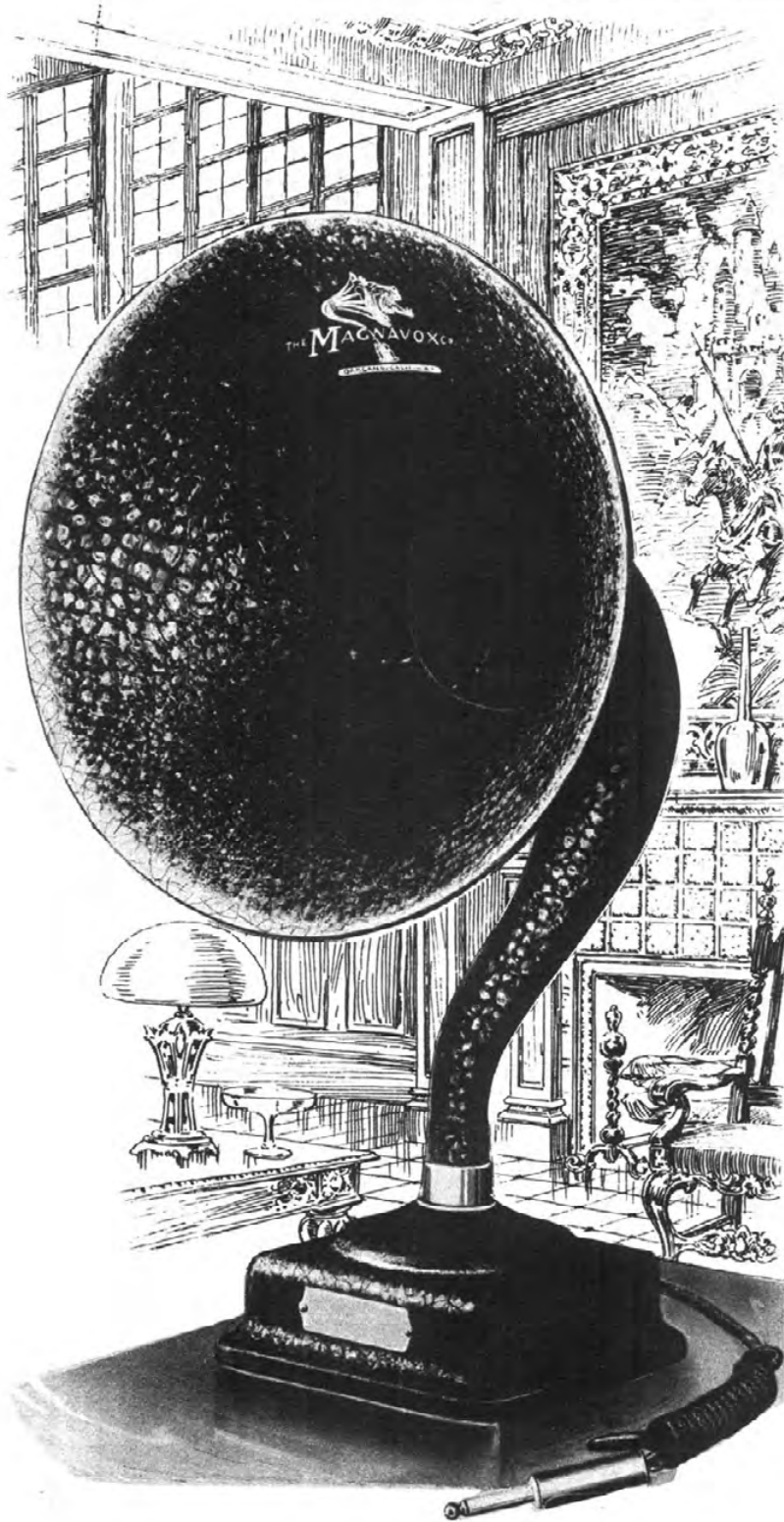

M4-  
\$25  
at all  
dealers

FOR THE many thousands of radio sets purchased during the holiday season, a Magnavox Reproducer would make all the difference between supremely beautiful and merely audible programs. A Magnavox for every receiving set: M4 at \$25., R3 at \$35. and R2 "The Radio Reproducer Supreme" at \$50.

THE MAGNAVOX COMPANY  
OAKLAND, CALIFORNIA

New York: Chicago: San Francisco:  
350 W. 31st St. 162 N. State St. 274 Brannan St.  
Canadian Distributors:  
Perkins Electric Limited, Toronto, Montreal, Winnipeg

**MAGNAVOX**  
REPRODUCERS—RECEIVING SETS—TUBES

the various taps on the tap switch number 17.

From stator plate connection of variable condenser number 12 to inside winding of honeycomb coil number 6.

From rotor plate connection of variable condenser number 12 to the outside winding of honeycomb coil number 6.

From stator plate connection of

variable condenser number 14 to inside wire of honeycomb coil number 8.

From rotor plate connection of variable condenser number 14 to outside winding of honeycomb coil number 8.

From stator plate connection of variable condenser number 16 to inside of honeycomb coil number 10.

From rotor plate connection of variable condenser 16 to the outside winding of honeycomb coil number 10.

## For the Inverse-Duplex Experimenter

By JOHN DeQ. BRIGGS

The Man Who Inverse-Duplexed the Neutrodyne

IN MY workshop are four receiving sets, all in active operation. An eight-tube superheterodyne is more or less permanently installed for "hack work" and as a standard for comparison. The original inverse duplex neutrodyne and the 3XP ditto are ready to operate on call.

But the fourth set, on the table in the middle of the room, is the real center of interest. It is a four-tube inverse duplex, without cabinet, with a 7x24 panel to which are attached a General Radio .0005 and two Hamnerlund .00025 variable condensers, two Pacent rheostats, a battery switch, and a double-pole, double-throw telephone switch for changing from loop to antenna. Also two holes for CRL potentiometers or variable resistances.

The baseboard is 24-12, soft wood,

wire tapped at 25 secondary, 8 turns No. 26 dcc primary wound over one end of the secondary. This pair are mounted horizontal at right angles.

Then there are two or three sets of Mr. Pfanstiehl's beautiful little coils, mounted at various distances and angles, arranged so that the relative angle can be varied instantly. This angle is best at about 28 degrees at a 6 1/4-inch distance.

A pair of coils must bring in CYL, Mexico City, on the loop. If it does not, the coils are condemned. All the above-mentioned coils have passed the test. One night the Pfanstiehl coils brought in this station very nicely on the loud speaker, using only three tubes. That was an exceptional night. Usually the fourth tube must be used for the loud speaker.

All this coil-testing has led more or

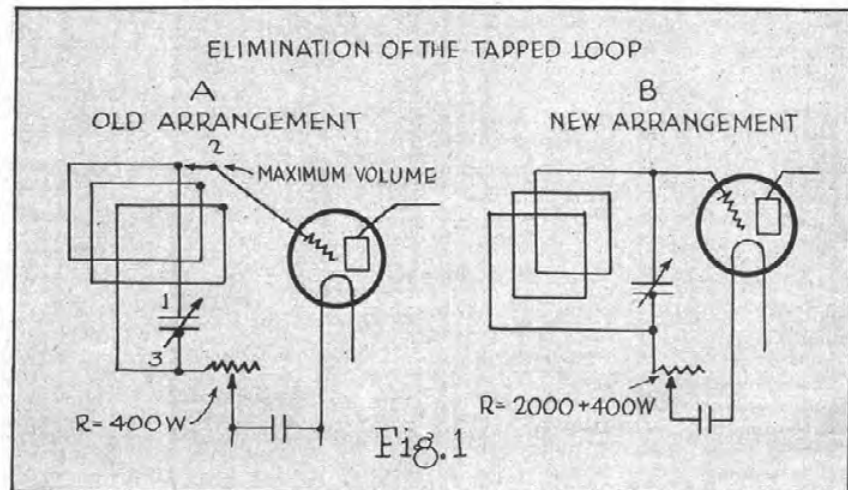

so that screws go in and come out easily. On it are three Stromberg Carlson audio transformers, four sockets, a choke coil (this was, in its younger days, the secondary of an old Fada AF transformer—iron core removed), and a considerable population of by-pass condensers.

All this apparatus has been moved round so much that the baseboard is honeycombed with screw holes, but it has finally come to rest in such a way as to leave an open space about 6x12 in the middle of the board. This space is tenanted night after night by different pairs of RF transformer coils. The eight leads to these coils have baby Fahnestock clips on them, so that a set of coils may be changed in half a minute.

All these coils have secondaries wound so that with the .00025 condensers they cover from 225 to 600 meters.

One pair look like standard neutrodyne coils. These have six turns primary and 67 turns secondary, tapped at sixteen for the neutrodyne. They are fastened to each other in the correct relative position, and then the unit is swung so that their planes are horizontal without disturbing their relative position. This is to minimize feedback into the loop.

Another pair is wound on 1 1/2-inch bakelite tubing, 130 turns No. 28 dcc

less directly to two simple but rather drastic changes in the fundamental circuit. The first of these completely eliminates the tapped loop. It is illustrated in Fig. 1. The tapped loop was a nuisance to make and was clumsy to operate. Connect the grid loop lead to the loop lead which goes to the condenser and stops there. Run one lead from a standard loop to this common wire. Run the other lead from the standard loop just where it went before—to the other terminal of the condenser. This latter should be the rotary plate terminal. This leaves the loop where, were it tapped, it would be set on the maximum tap.

Then put a 2000 ohm resistance in series with the 400 ohm potentiometer before specified in the circuit. (See the September *Radio in the Home*). Short out the 2000 ohms for out-of-town work, using only the 400, which gives a fine adjustment. Cut in the 2000 for locals.

The CRL people very kindly have made me several special resistances for this purpose, built like their potentiometer, with 400 ohms spread over three-fourths of the arc, and 2000-3000 ohms in the remaining one-fourth. This little instrument is ideal. For locals, I simply swing the knob round and cut in the high resistance and I have the smooth, fine adjustment on the 400 for distances. My tapped loops are now gathering dust

on the wall, and a standard "Duo-Spiral" does all the loop work.

The second change is more tricky, but is well worth while. It came about through my using some special coils Mr. Pfanstiehl made for me with too many turns in the primary. These were intended to be stripped down until there was no oscillation.

Without being too technical, there are a good many ways of stopping oscillation in RF tubes—doing away with the capacity feedback between the grid and plate in the tube. We shall consider three.

First is the Hazeltine method of neutralizing. Second, cutting down the number of turns in the primary until oscillation stops. Third, introducing resistance into the primary circuit.

The first of these methods is efficient, but mean to adjust. As Mr. Neely and Mr. Grimes have said, the inverse duplex neutrodyne hasn't the tendency to oscillate that a straight

eliminating the tapped loop we've lost one control, so there are no more than we started with. Again the CRL 2000-ohm potentiometer, used as a series resistance, comes to the rescue.

This leads to change number three, which is the most interesting, because it goes Mr. Grimes one better and does to the second plate circuit what he has already done to the first one, though for a different reason. Since this is a reflex circuit, the place where we have introduced this new resistance is part of the *audio* plate circuit as well as of the *radio* plate circuit. Now we don't want this resistance in the *audio* circuit—it is no use there and some detriment. The answer is to separate the audio and radio circuits which come from the same plate as in the diagram, Fig. 2.

Connect the plate directly to "P" on the audio transformer, which will send the audio plate current directly to its destination instead of detouring it through the RF transformer as in

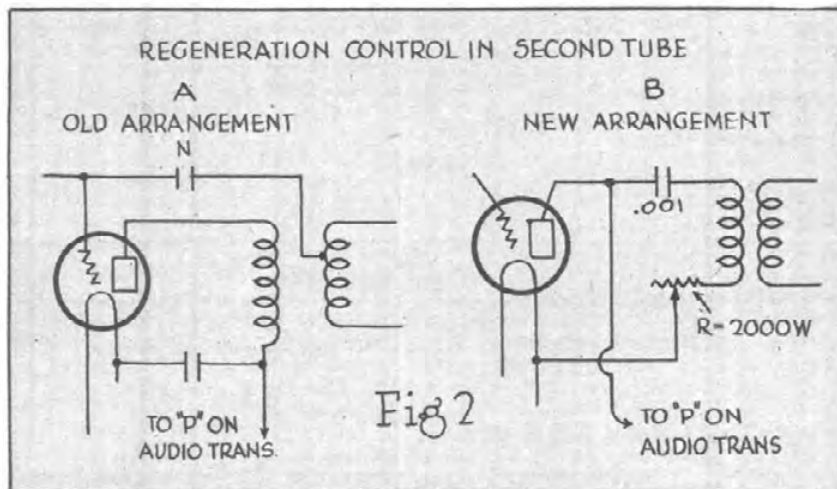

neutrodyne has—on the higher wave lengths. But get below 300 meters and you'll find the neutrotons very necessary. The second method—cutting down the number of turns in the primary—has one serious drawback. If you take off enough turns to stop oscillations on the shorter wave lengths you slash your volume on the longer waves. If your set will bring in KFNF without oscillating, KSD will be very weak. Consequently, in taking a turn off one of those Pfanstiehl primaries, one feels like the proverbial Scotchman when the contribution plate is passed—very reluctant. It seems wicked to do it.

The answer is in the third method. Don't abuse the feedback—use it, but control it. Keep a turn or two too many on the primary of the second RF transformer (whether it be Pfanstiehl or any other type of coil—the method is applicable to all the coils I have mentioned). Introduce a 2000 ohm noninductive variable resistance into this primary plate circuit, and cut in just enough of this resistance to keep the second tube from oscillating. You will need less for the long waves than for the short ones. It makes a velvety regeneration control and assures you the maximum volume on every station. And it isn't an extra control, either, for in

the original circuit. Ship the *radio* plate current through its by-pass condenser (don't leave this out or you will be four dollars sorry) to the plate connection of the primary of the RF transformer (be it Pfanstiehl or otherwise). Connect the other lead of this primary to one side of the 2000 ohms resistance. Connect the other side of the resistance directly to the positive filament. These changes are clearly shown in the diagrams.

We now have resistance control of regeneration in *both* tubes, the first tube by the original potentiometer in the *grid* circuit, the second tube by the new resistance in the *plate* circuit. To operate, you simply carry as little resistance as you dare in both circuits. If the set tends to spill over, a slight change in one resistance or the other will iron it out beautifully. And you can get way down below 250 meters, too.

For any one who wants some fun and a lot of trouble, I may suggest another method of using regeneration—inductive feedback instead of capacity feedback. Take enough turns off the primary to stop oscillation. Then put your coils just enough out of line so that you get some magnetic coupling between them. You'll get

(Continued on Page 58)

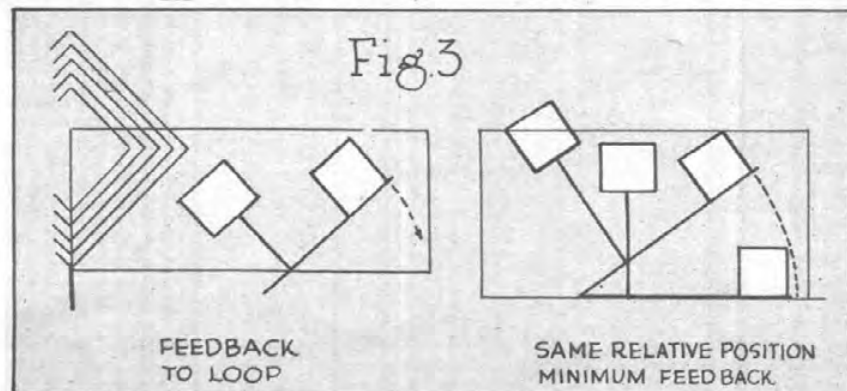

# FADA Radio



FADA Neutroceiver No. 175-A

Mahogany cabinet. Inclined panel and roomy battery shelf. 5 tubes. Price (less tubes, batteries, etc.) \$160.



## Indecision vanishes when you hear the FADA

RADIO shopping ends triumphantly when

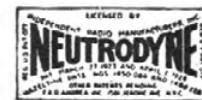

you find the FADA. People who know radio and have conducted comparative tests say that the Neutroceiver is the best they ever tried. Have the FADA Neutroceiver demonstrated in your home. Listen to its marvelously faithful reproduction. Tune in a distant station yourself loud and clear and see how easy it is. Observe the beautiful cabinet design. You will exclaim: "At last! This is just the radio set I want!"

If you prefer a set with self-contained loud speaker, the FADA Neutrola Grand meets your desire in this respect, as in all others. Whether FADA Neutrodyne re-

ceivers are the first or the fifteenth make you

investigate, they will be your final choice, for they will convince you that you need look no further. Through the FADA Neutrodyne your radio wishes become realities. See your dealer.

F. A. D. ANDREA, INC.  
1581 JEROME AVENUE, NEW YORK

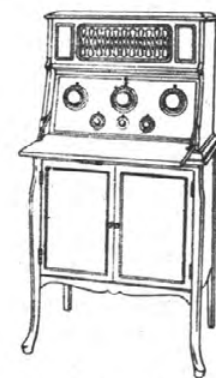

FADA Neutrola Grand No. 185-90-A

The five-tube Neutrola 185-A, mounted on FADA Cabinet Table No. 190-A. Price (less tubes, batteries, etc.) \$270



## Do you tune-in quickly?

What a difference a good dial makes

**T**HERE are dials and dials and there's a big difference in them. Some are much easier to read than others. The hand seems to fit the knobs of some exactly. Enjoy the pleasure and comfort of tuning in with greater ease and speed than ever before. Use Na-Ald Super De Luxe Dials and experience real dial satisfaction.

Station after station can be tuned in quickly and comfortably. Even if you tune in over and over again, searching for distant stations until late into the evening, you will experience no eyestrain, no finger-cramps when you turn the big generous-sized knob. It fits your fingers naturally.

It took engineers and optical experts months of careful study to perfect the scientific design of Na-Ald Dials. Stop-watch tests developed the best possible position of numbers, and lengths, spacing and width of lines.

You can obtain Na-Ald Dials at radio, electrical and hardware stores. Use them not only in the set you build, but also install them in the set you buy, if not already adopted by the manufacturer. Super-De Luxe, 75c; other sizes, 35c, and 50c.

ALDEN MANUFACTURING COMPANY  
Also makers of the famous Na-Ald Sockets  
Dept. J-3, Springfield, Mass.

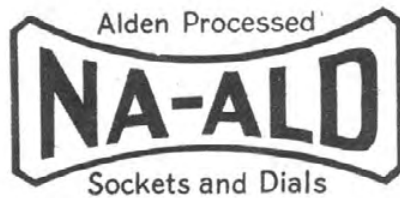

Na-Ald also manufactures a complete line of Bakelite Sockets for all tubes. De Luxe with special clean-easy feature, 75c; others 35c, 50c, 75c.



**FREE BOOKLET**

*Mail Coupon*

Send for free copy of radio booklet—"What to Build" showing a number of the best tested and selected circuits.

ALDEN MANUFACTURING COMPANY,  
Dept. J-3, Willow Street,  
Springfield, Mass.

Please send free copy of booklet "What to Build," showing tested and selected circuits.

Name .....

Address .....

City..... State.....

## Twelve Hundred Kids on the Air

(Continued from Page 18)

one time two boys of the first grade were scheduled to sing a duet, but through some mistake one of the boys did not show up. When we signed off and the one who was there had not been allowed to sing the song alone, which of course he could not do, he was very brave in keeping back the tears of disappointment. The tears were in his eyes all right, and it was only by cheering him up with the promise of a solo some time that we finally had him smiling again.

As I say, it is hard to write about these happy kids, because the looks on their faces, their habit of swaying in a group while singing, their intense interest and enthusiasm must be seen to be enjoyed.

We have read to them some of the letters we have received concerning their broadcasting and I believe every one of them now realizes that they must all do their best because they can never tell who is listening in and what lonely soul they may be cheering. Letters from shut-ins, old people with lonely lives, soldiers flat on their backs in Government hospitals, have come in and told us how much they enjoy the happiness of the Mooseheart kids.

So that the broadcasting station will not become a labor instead of a pleasure, every night is devoted to one particular group. This makes the children look forward to this particular night and serves as an incentive for them to do their best work in preparation.

They seem to have very good memories. The Girls' Glee Club was on the program one night and they were desirous of having me sing and play so that they could see how it was done. There was not time to do it because the girls had to get back to their respective residences. The next time the girls came in a spokesman, very seriously, handed me a long and very formal petition to the effect that I had promised them to sing. They listed the songs they wanted sung (I think it contained everything I have ever sung or heard of). It included names of all of the girls of the Glee Club and also names of girls from other organizations. What could I do but go through the whole list as best I could?

Another group that is very interesting is the one that is called the Juvenile Band. This consists of about thirty boys and girls about 7 years old. Instead of playing real instruments they use trombones, cornets, horns equipped with little paper vibrators, with a background of little drums, triangles, bells, etc. They have little uniforms and the

leader has a very impressive uniform and manner with which he directs them. They take it very seriously and they make almost as much noise singing into these fake horns as the real band does on their real instruments. A solo on one of these instruments is more important to one of them than a solo in any other organization out here.

One of the things that interest me is the fact that the younger the child is the less self-conscious he is and the more anxious he is to broadcast. Some of the older boys and girls are a little bit timid and stage-frightened about their work, but the younger children can hardly wait to get on the stage and take their turn. They almost push the one who precedes them away so they can get out and do their bit.

The Mooseheart Concert Band of boys of the high school is a famous organization. This band has traveled on concert tours all over the country and rivals many bands of professional musicians. When they "let go" on a march the shivers run up and down my spine because they play and play as though their lives depended on it. When they march off leading the Cadets to the parade ground with colors flying, it is a real thrill to listen and watch and wonder just what these fine specimens of boyhood and young manhood would be if there was no Mooseheart to father them and develop them.

There they go, four hundred strong, assembled from all over North America, the almost finished products of "the school that trains for life," fatherless and yet with many fathers.

As I said, only dependent children of deceased Moose are admissible. This does not exclude their mothers. There are many mothers right with their children. Some of them are matrons of the homes, some are doing clerical work—all are given the opportunity to be with their children and yet not feel dependent, because they have congenial work for which they are paid regular salaries.

It is a marvelous dream come true. Mooseheart children are happy, and I hope that radio fans will absorb some of that happiness whenever they tune in WJJD.

Remember that they are some of our future citizens, not radio artists, and I like to feel that you, when you hear us, are really listening in, almost eavesdropping on the Mooseheart children, instead of our feeling that we are formally presenting a program for you to listen to. In other words, we are having a good time and we'd like to have you join us, if only by proxy, and "May You Laugh in Your Dreams."

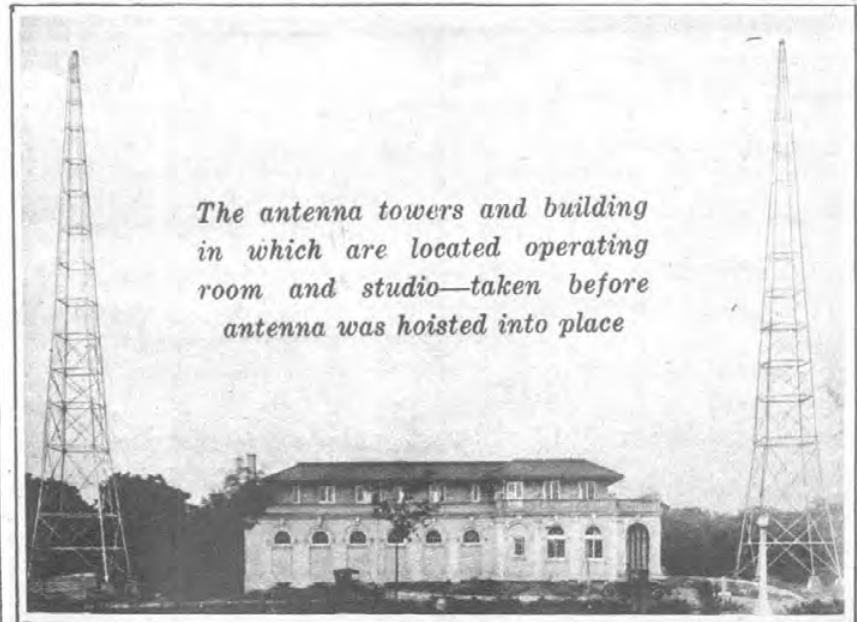

The antenna towers and building in which are located operating room and studio—taken before antenna was hoisted into place

# For The Advanced Student

## Audio Frequency Intertube Transformers

By BENJ. OLNEY

Engineer of the Stromberg-Carlson Company

THIS department is being started in response to a large volume of requests that this magazine furnish a regular series of technical articles letting our more advanced readers know the modern progress of experiments and tests in various laboratories.

We have heretofore tried to make this magazine strictly a magazine for beginners, but we have been convinced that the beginner very soon graduates into the advanced stages of radio and that he becomes hungry for the technical results of engineering research which would be beyond the original scope of this periodical.

Consequently we have established this department and each month we will give technical articles such as the one here presented in the hope that those of our readers who have passed the novice stage in radio will be enabled to keep in touch with the latest progress in the art.

H. M. N.

### Introduction

EARLY audio frequency intertube transformers were designed for amplifying telegraph signals only, their constants being chosen to give maximum amplification at a single frequency in the neighborhood of 1000 cycles.

At the inception of radiophone broadcasting, transformers of this

former. Intertube transformers only as used in ordinary radio receiving set cascade amplifiers will be discussed.

### Frequency Requirements

For the transmission of speech over commercial telephone lines a frequency range of from 200 to 2000 cycles has been found satisfactory. The reproduction of music imposes much more severe requirements, a large pipe organ, for instance, having fundamental tones as low as sixteen cycles, while the higher harmonics of some orchestral instruments extend upward beyond 10,000 cycles.

It has been found, however, that a frequency range of from about 50 to 5000 cycles is virtually sufficient for good reproduction of most music. It is possible even to curtail this range somewhat at the low frequency end and still preserve the sensation of pitch for the lower notes, it having been found that the pitch of very low notes is carried to the ear mainly by their higher harmonics. ("High Quality Transmission and Reproduction of Speech and Music," Martin and Fletcher, *Journal A. I. E. E.*, March, 1924.)

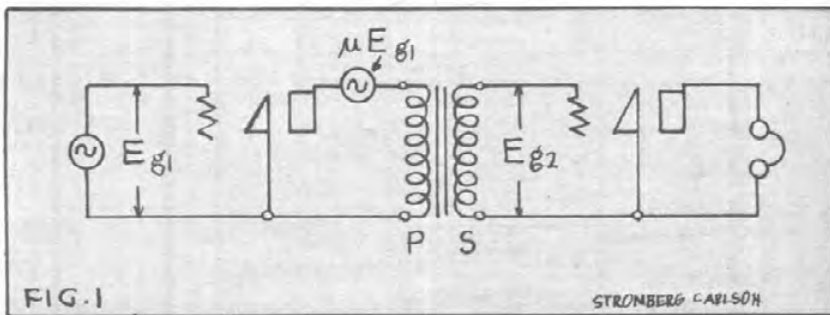

Fig. 1—Transformer Working Between Vacuum Tubes

type were used in many receiving sets; also, in the ensuing rush for radio equipment, numerous other designs almost equally unsuited for radiophone reception were placed upon the market. Some were copies of the telegraph type transformer while many others apparently were not based upon a correct conception of the requirements imposed in amplifying speech and music with little distortion.

In the early enthusiasm of the radio audience over a novel and fascinating form of entertainment, the distorted reception resulting from the use of such transformers either was tolerated or passed unnoticed; but later, when listeners became more critical and began to make invidious comparisons of radio reception with other forms of reproduced music and speech, the demand arose for a higher standard of quality. In the meantime, the subject of audio frequency amplification was being investigated in the laboratories of some of the larger manufacturing concerns and engineering schools with the result that transformers which represent a high development of this branch of the art are now available.

It is the purpose of this article to discuss some of the factors which enter into the design of the audio frequency transformer, to show the performance characteristics of various types and to describe some of the laboratory and factory tests employed during the development and manufacture of a particular trans-

In general, extension of the frequency range of the audio amplifying system in a receiving set above 5000 cycles is of little advantage because of the following considerations. The modulated carrier of a radiophone station consists of the carrier frequency and two side bands, one side band having a frequency equal to the carrier plus the modulating frequency and the other equal to the carrier minus the modulating frequency.

If both side bands are to be received, the tuning circuits in the receiving set must pass a band of frequencies numerically equal in width to twice the maximum modulating frequency. It will be seen that, as the carrier waves of broadcast stations are now spaced 10,000 cycles apart, a receiving set having broad enough tuning to admit modulating frequencies above 5000 cycles would be subject to interference from stations operating on adjacent wave lengths.

As a matter of fact, receiving sets with even a moderate degree of selectivity may appreciably attenuate modulating frequencies above 3000 cycles due to the shape of the resonance curve, while other sets with flat-topped, steep-sided selectivity characteristics may produce little attenuation of frequencies up to perhaps 5000 cycles, but may virtually eliminate those above this point.

As the modulating frequencies convey the characteristics of the transmitted sounds and are the only ones

# A new Tungar!

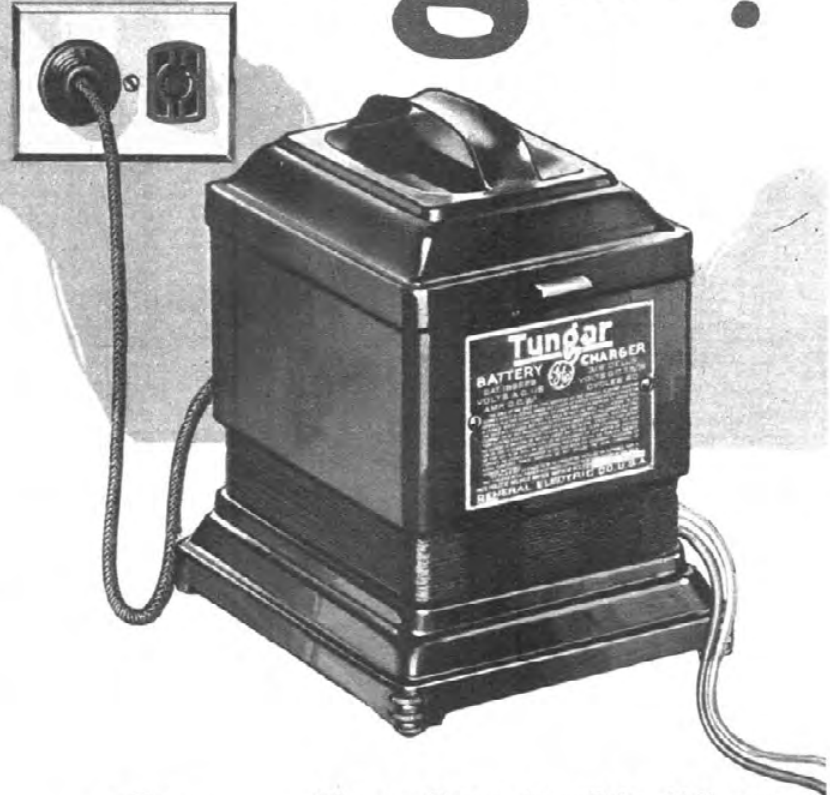

300,000  
Tungars  
already  
in use!

The new Tungar charges both radio A and B batteries, and auto batteries, too. Two ampere size (East of the Rockies) \$18

The Tungar is also available in five ampere size (East of the Rockies) \$28

60 cycles—110 volts

The new Tungar does all the old Tungar did—and more. It will charge both radio A and B batteries, with no change except slipping the wire from one terminal to another. It charges 2, 4 or 6 volt A batteries—24 to 96 volt B batteries—and auto batteries, too.

It is simpler than ever to use. Just two clips and a plug. No need to disconnect your battery from your set, or make any change in the wiring. The Tungar charges overnight while you sleep. And it makes no disturbing noise.

It is more compact than ever. It has a new bulb, unchanged in principle, but more convenient in size and use. G-E research has made a good product better!

Keep your batteries charged with a Tungar—and get the most out of radio.

# Tungar

REG. U.S. PAT. OFF.

## BATTERY CHARGER

Tungar—a registered trademark—is found only on the genuine. Look for it on the name plate.

Merchandise Department,  
General Electric Company,  
Bridgeport, Conn.

# GENERAL ELECTRIC

# The Latest Achievement

## In Audio Amplification

Greater  
Volume  
With a  
Quality  
of Tone  
That Is  
Unique



The  
Type 285  
Audio  
Amplifying  
Transformer  
  
Price  
**\$7.00**

The current radio season has seen the advent of many new audio transformers—some of them worthy contributions to better amplification.

Now comes the announcement of the new General Radio transformer which sets an even higher standard of amplification and places the erstwhile leaders in the mediocre class.

Discriminating radio listeners—this instrument has been designed for you. It is an achievement of which the designing engineers are justly proud; it is an instrument which merits the admiration of trained radio ears.

High and low notes are amplified evenly over the whole audio range so that instrumental or vocal tones are reproduced individually or in combination with a naturalness which delights the most critical radio listener.

Seldom is more than one transformer necessary to operate a loud speaker with good volume.

If you want the best there is in transformer design, the type 285 should be your choice.

**Price \$7.00**

Ask for them by Name at your Radio Dealers

**GENERAL RADIO Co**  
Cambridge, Mass.



Write for Descriptive Folder 285-J

effective in the audio apparatus of the receiving set, it is unnecessary to design the audio transformers to respond to frequencies which are virtually cut off by the preceding radio tuning circuits.

### Transformer Characteristics

When operated within its proper limits, the output power of a vacuum tube in an amplifier is a function of its input voltage, as no current flows in the grid-filament circuit under the

It is convenient for purposes of analysis to simplify the circuit of Fig. 1 as shown in Fig. 2. Here the A-C plate voltage is  $E_1$ , the plate impedance is imitated by the resistance  $R$  and the voltage impressed by the transformer across the grid-filament circuit of the following tube is designated by  $E_2$ . The ratio of the voltages intertube called the "voltage amplification," represents the effective amplification produced by the transformer when operating in

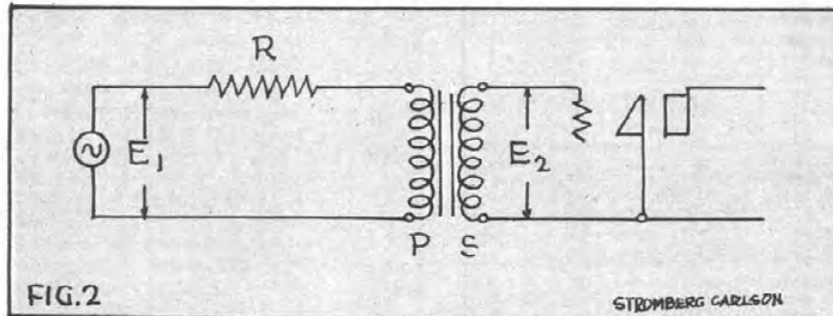

Fig. 2—Illustrating Voltage Amplification of Transformer

stipulated condition. Therefore, the most satisfactory basis upon which to compare intertube transformers is one which considers the voltage that they are able to impress across the grid-filament circuit of a vacuum tube rather than their input-output power ratio.

In Fig. 1 is shown a transformer working between two vacuum tubes in an amplifier. If an alternating voltage indicated by  $E_g$  be impressed across the grid-filament circuit of

the amplifier circuit, and is the basis upon which intertube transformers are usually compared.

It is possible to measure voltage amplification quite accurately by methods which will be discussed later. The results of such measurements over a wide frequency range yield, when plotted, a curve which probably gives more information as to the performance characteristics of the transformer than any other test which may conveniently be made. A group

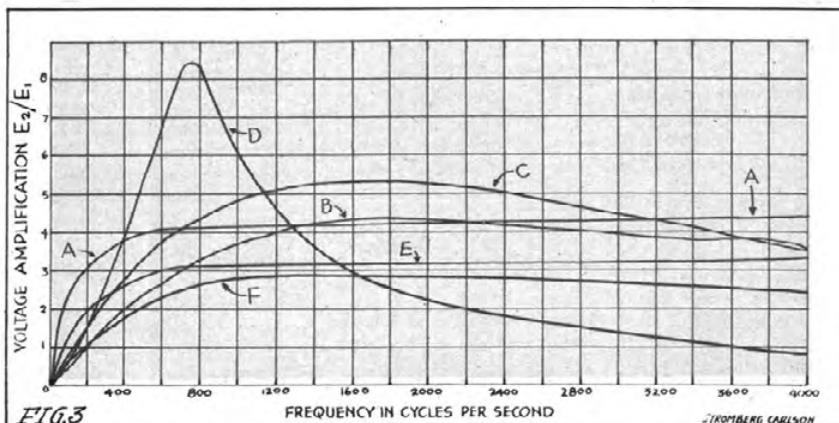

Fig. 3—Voltage Amplification Curves of Various Transformers

the first tube there will be developed in the plate circuit of that tube another voltage equal to  $E_g$  multiplied by  $\mu$ , the amplification factor of the tube. This second voltage may be considered as a "point-source" of electromotive-force inserted in series with the A-C plate impedance of the tube and the primary of the transformer. The portion of this voltage acting across the primary of the transformer is stepped up and impressed by the secondary across the grid-filament circuit of the succeeding tube.

of such voltage amplification curves is shown in Fig. 3 and will later be discussed.

The characteristic of an ideal transformer would consist of a straight horizontal line intersecting the axis of voltage amplification at a value equal to the turns ratio; that is, it would produce uniform voltage amplification at all frequencies and, consequently, could introduce no "frequency distortion."

The curves of all actual transformers, however, start from zero because the transformer obviously is

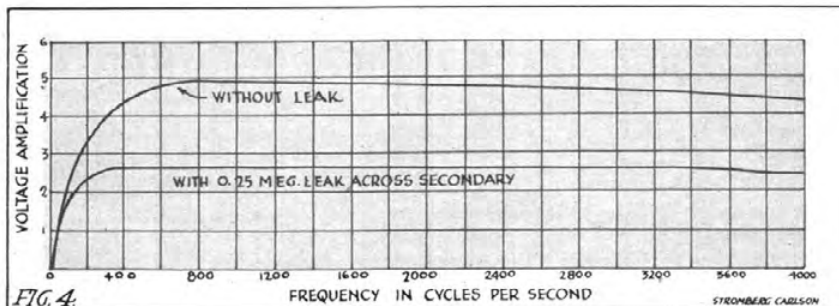

Fig. 4—Amplification Curves of Transformer With and Without Resistance Shunt Across Secondary

inoperative at zero frequency or direct current. This latter feature being inherent, it would appear from the standpoint of minimum distortion that the best practical transformer is one whose amplification curve flattens out at the lowest frequency into a straight line representing an amplification value equal, approximately to the turns ratio. It would seem, also, that the straight portion of the curve might advantageously have an upward slope so as to compensate to some extent for the attenuation of the higher frequencies previously mentioned as due to sharply selective tuning circuits.

The constants of an intertube transformer which most influence its performance are the self and mutual inductance of the windings and their effective capacity. The two former are determined by the number of turns and arrangement of the windings and by the dimensions, shape and material of the core, while the effective capacity is chiefly affected by the size and the arrangement of the

more nearly equal to  $E_1$ , as the frequency is increased.

It should be noted that the nearer equal these voltages become, the less a given change in frequency will affect their ratio. It will also be seen that by increasing the inductance of the primary we may cause this ratio to approach unity more rapidly with increase in frequency.

According to the approximations previously made, the ratio of the primary voltage to the impressed voltage which we have just been discussing, becomes, when multiplied by the turns ratio, the voltage amplification of the transformer. We may now illustrate the remarks in the last paragraph by saying that, given two transformers of the same ratio working in identical circuits, the amplification curve of the one having the higher primary inductance will rise more steeply at the low frequency end and will flatten out at a lower frequency into a straight line representing an amplification equal approximately to the turns ratio.

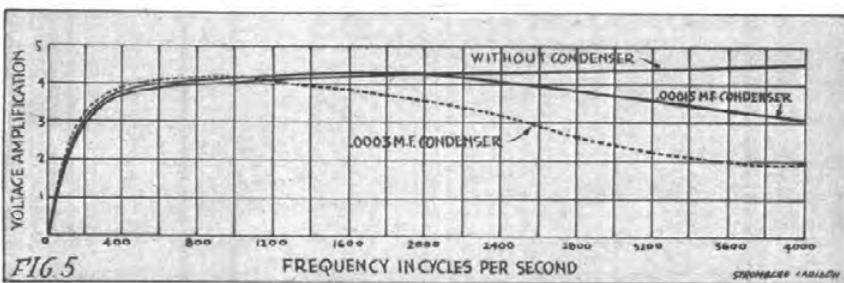

Fig. 5—Amplification Curves of Transformer With and Without Capacity Shunt Across Secondary

windings with respect to each other and to the case and core.

As the resistance of the grid-filament circuit is extremely high when a vacuum tube is properly operated, the load upon the secondary of the transformer may be considered as that due to the sum of the winding and vacuum tube capacities. The reactance of this comparatively small capacity is very high at the lower audio frequencies so, at these frequencies, the transformer may be considered as operating on no load, the reaction of secondary on primary neglected and the voltage induced in the secondary taken as equal to the primary voltage times the turns ratio. These approximations enable us quite simply to account for the slope of the amplification curve at the low frequency end and for its straightening out in well-designed transformers.

Referring to Fig. 2, the voltage across the primary of the transformer is less than the impressed voltage by the drop around the plate resistance  $R$ . The impedance of  $R$  does not change with frequency while that of the primary increases with frequency, and the division of voltage between them is directly proportional to their impedances.

Neglecting the resistance of the primary, which is small compared with its reactance and with the plate resistance, the primary is seen to be an inductive reactance whose value is equal to the inductance of the winding multiplied by the frequency times a constant number. Thus, with a constant impressed voltage  $E_1$ , and a constant plate impedance  $R$ , the voltage across the primary and, consequently, that across the secondary, will depend upon the inductance of the primary and the frequency.

With a primary of fixed inductance, increasing the frequency causes the voltage across the primary to increase and, consequently, that across  $R$  to decrease, because their vector sum is always  $E_1$ , the voltage across  $R$  finally becoming insignificant in comparison with that across the primary. This is equivalent to saying that the primary voltage becomes

Thus, high primary inductance is essential to effective amplification of the low frequencies which are so important in music, and to the reduction to a minimum of the frequency distortion at the lower end of the range which is inherent in all transformers.

As an example of this, compare the curves of transformers A and B, Fig. 3, which have the same rated turns ratio (4 to 1) and which were measured under identical conditions between UV201-A tubes. The primary inductance of A, measured at 1000 cycles, is approximately twenty henrys, while that of B is about three henrys. Note that at a frequency of 200 cycles, A produces an effective amplification of three, while that of B is one, or the same as would result if the transformer were omitted and the input voltage impressed directly across the grid-filament circuit of the following tube.

At 100 cycles transformer A produces an amplification of 2.25, while that of B is 0.5; that is, B is no longer functioning as an amplifying device and the voltage which it applies to the following tube is only 50 per cent of that which would result if the transformer were omitted and the input voltage applied directly at the tube. The amplification of A reaches its rated turns ratio value at 600 cycles while that of B only reaches the same value at 1200 cycles.

In order to give an idea of the wide variation of primary inductance among different commercial designs of transformers, it can be stated that transformer A has, probably, the highest primary inductance (twenty henrys) of any of its type now available, while the writer has measured some transformers with the same turns-ratio having a value of only 0.2 henry.

So far we have been discussing the action of the transformer over only the lower portion of the frequency range and have, for the sake of simplicity, made the nearly true assumption that the load upon the secondary and the consequent reaction upon the primary were nil.

At the higher frequencies, however,

# Why Radio Receivers Differ So Widely in the Quality of Their Tone



## What Makes a Beautiful Tone

As radio becomes less of a stunt instrument for fans to play with and more of a musical instrument in the home, people are demanding, above every other value, TONAL CHARM. Clear tone, of course, but more than that, lovely tone—all of the beauty which distinguishes fine singing and the best in musical performance.

You cannot get that out of an ordinary radio set any more than you can get it out of a poor piano. The tone is deprived of those minute variations which constitute tone timbre and make the emotional appeal in music. The sound waves are defective. The pitch may be absolutely true and correct, but the tone is thin and lifeless. You do not get the delicate overtones which give to the human voice its supreme charm.

These delicate overtones are lost in the average radio. They are blotted out by the disturbance of the forward radio stream, by the feeding back of stray energy. The two conflict. They are not in phase. The true signal does not mesh with the feedback. Neutralizing condensers may or may not stop the resulting squeals and noises. But they never can restore the overtones.

## The Musical Value of Overtones

Every human voice has its characteristic overtones which identify it. That is how you distinguish one from another. Every musical instrument also has overtones peculiar to itself. That is how you can tell a piano tone from a cello tone, of exactly the same pitch, and distinguish a good instrument or performer from a poor one. The brilliancy of the violin, the liquid clarity of the piano, the rich resonance of the cello, are made up of overtones which require the most delicate reception in radio to reproduce. To lose them is fatal to musical enjoyment.

To get rich, sweet tone from a distance has been a difficult problem in radio. The more amplification, the more internal noise was developed; the more devices employed to neutralize it, the more damage is done to the overtones. That dilemma has long baffled radio engineers. IT HAS NOW BEEN COMPLETELY SOLVED IN THE NEW PFANSTIEHL. Solved, not by more complications, but by the utmost simplicity. All neutralizing devices are done away with. They are not needed. The Pfanstiehl SYSTEM of radio reception avoids all the errors which have hitherto required neutralizing.

## No Errors to Neutralize

The circuits are structurally correct. They absolutely control the forward stream of radio energy. No feedback is possible, and hence no internal noises. By what scientific means this was accomplished makes an important story for radio technicians. They realize what Pfanstiehl has done. But most radio users are not technicians. They want results. In the new Pfanstiehl they get them.

Actual demonstration will prove it. Comparison with any one of the long line of "dynes" will show a remarkable difference in clear, sweet tone and real music. Every radio purchaser owes this demonstration to himself. If your radio or music dealer does not have a Pfanstiehl to show you, we can quickly get one to him.

## A Unique "Station Finder" Takes the Guesswork Out of Tuning

A unique feature of the Pfanstiehl Model 7 is a "Station Finder," which takes the guesswork out of tuning and enables even the inexperienced to tune this receiving set quickly and without difficulty.

From the radio program in the daily newspaper or radio magazine, ascertain the "wave-length" of the station you want to hear and also the time at which it is scheduled to broadcast.

1. Find this "wave-length" or number of the lower scale.
2. Read the number directly above it on the upper scale, and set each of the three large dials to this reading.
3. Tuning may now be sharpened by adjusting the large dials slightly, one at a time, with the small vernier knobs below. Adjustment of the large dials to a fraction of a degree, enables you to secure the sharper tuning needed for maximum results from distant stations.

# Pfanstiehl

Model 7 Receiver

A 5-tube Receiver using the new system of tuned radio frequency

MODEL 7 RECEIVER

A 5-Tube Receiver Using the New System of Tuned Radio Frequency

PFANSTIEHL RADIO COMPANY

24 S. Second St., Highland Park, Ill.

# Volume and Clarity



## with Kellogg Transformers



A Radio Frequency Transformer of the aperiodic type suitable for all sets with which tuned radio frequency is desired. Also used for one stage of radio frequency

amplification ahead of regenerative sets to prevent re-radiation.

Consider these points of superiority:

- No dope to hold windings in place.
- Soldered connections.
- Mounting bracket holds coil at correct angle.
- Minimum rubber used in form.
- Lowest possible loss, with greatest transfer of energy.
- Works with any .0005 condenser.
- Secondary arranged with suitable taps for biasing features.

This transformer makes the construction of a radio frequency set an easy matter, assuring best possible reception with widely varying types of circuits, including reflex. Built and guaranteed by Kellogg Switchboard and Supply Co.

No. 602 Radio Frequency Transformer at your dealers for \$2.35 each.

Kellogg Audio Frequency Transformers are the "stepping stones" of modern amplification.

Clear, accurate reproduction assured over the entire range of the musical scale.

Plainly marked, accessible terminals.

It is acclaimed by test to be the best.

- No. 501 Audio Frequency Transformer Ratio 4 1/2 to 1—
  - No. 502 Audio Frequency Transformer Ratio 3 to 1—
- \$4.50 each

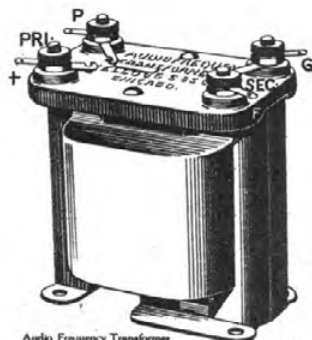

**KELLOGG SWITCHBOARD & SUPPLY CO.**

1066 WEST ADAMS STREET, CHICAGO

the effect of the winding and tube capacities as a load becomes a factor in the performance of the transformer because, as the frequency is increased, the impedance of this load becomes lower and considerable current begins to flow through it. This current in the secondary induces a voltage in the primary in such phase that the impedance of the primary circuit is lowered and more current flows therein also. The transformer windings and the plate circuit of the preceding tube are of comparatively high resistance which, as soon as this increased current begins to flow, pro-

ally large, so resonance with it takes place at a comparatively low frequency and may cause the amplification curve to rise more sharply at the lower slope and sooner reach the approximate turns-ratio value. The leakage reactance in a well-designed transformer is comparatively small, so resonance with it occurs at a higher frequency and may act to increase the amplification over that represented by the turns-ratio, thus causing the curve to slope upward and to remain straight over a greater portion of its length. At frequencies above this second resonance point the

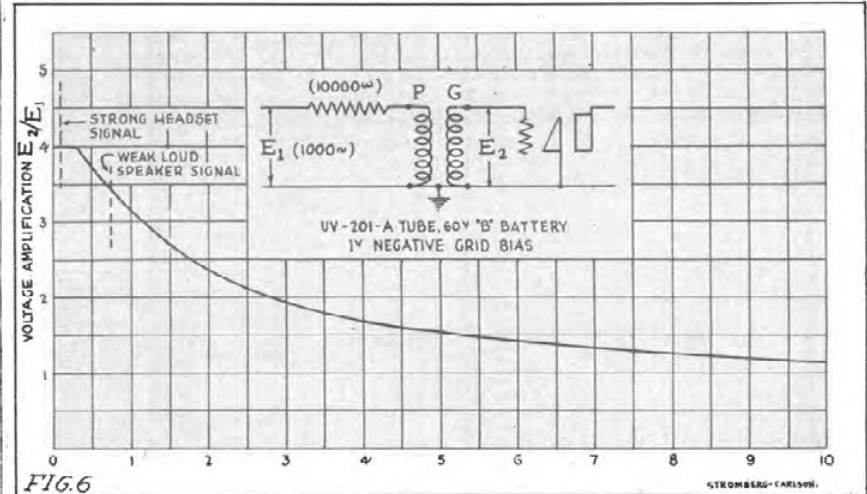

Fig. 6—Variation of Transformer Amplification With Input Voltage Due to Grid Current

operates further to reduce the amplification because of its effect upon the ratio of primary voltage to impressed voltage as explained in the discussion of the action of the amplifier at the lower frequencies.

Now, when we consider that the impedance of the secondary load as viewed from the primary side of the transformer is inversely proportional to the square of the turns ratio, we find that with the same effective capacitance more voltage drop in the circuit and consequently a reduction in amplification. At the same time, this lowering of primary circuit impedance

amplification falls off rapidly for the reason given in a previous paragraph. Thus good design requires that the second resonance point fall outside the frequency range which it is desired to receive. When properly proportioned with respect to the other transformer constants, the winding capacity thereby becomes an advantageous rather than an undesirable factor. Curves A and E, Fig. 3 illustrate this point.

Reference may now be made to the reason why it is not feasible to increase indefinitely the primary inductance in order to secure effective

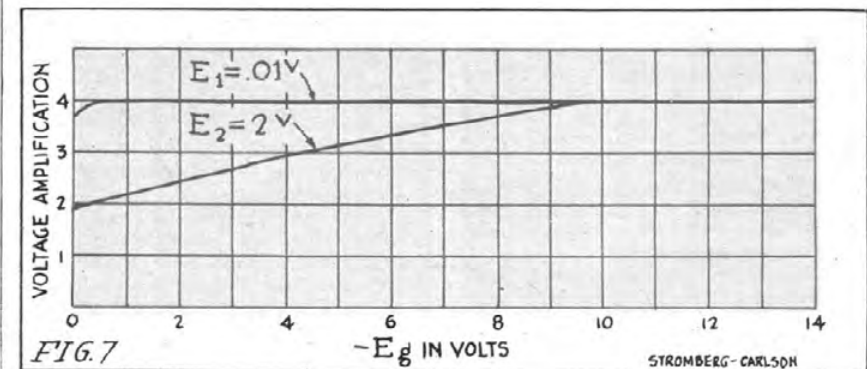

Fig. 7—Variation of Transformer Amplification With Negative Grid Bias

city across the secondary, the frequency at which reduction of amplification due to the above effects begins to take place is lowered very rapidly as the turns-ratio is raised. For an example, compare the curves A, C, D and E, Fig. 3. The rated turns ratios of these transformers are 4, 6, 10 and 3 to 1, respectively. The characteristic of D shows it to be utterly unfitted for radiophone reception, but, nevertheless, it is stated by its makers to function with a minimum of distortion.

Another effect of the winding and tube capacity is that due to resonance with the mutual impedance and the leakage reactance of the transformer ("Telephone Transformers," W. L. Casper, Journal A. I. E. E. March, 1924). The mutual impedance is usu-

amplification of extremely low frequencies. With a given core and winding arrangement the inductance is a function of the number of turns, while the effective capacity of the windings depends principally upon their size. Even with the smallest sizes of wire which may commercially be used and in the most careful design, a limit is reached where further increase in the number of turns is attended by increase in the effective capacity beyond the point where attenuation of the higher frequencies within the range to be transmitted begins to take place. Also, with a given number of primary turns, the turns-ratio becomes a factor in determining the size and, therefore, the effective capacity of the transformer. Thus the total number of turns and,



consequently, the mutual inductance is the factor which is finally limited by the wind<sup>ing</sup> capacity.

It is a much simpler design problem to secure a long, straight characteristic in a low ratio than in a high ratio transformer, although low ratio transformers of poor design are frequently encountered. Examples, respectively, of good and poor 3 to 1 ratio transformers are shown by curves E and F, Fig. 3.

The writer believes that the most satisfactory compromise between amplification and distortion may be secured in a 4 to 1 ratio transformer designed to possess the highest inductance possible and still keep the amplification characteristic straight at the upper end of the broadcast frequency range. It is impossible to secure a long straight characteristic when employing a much higher turns-ratio, while below this value amplification is sacrificed without a clearly recognizable reduction of distortion.

Apart from its other undesirable consequences, too high a turns-ratio tends to cause overloading of the succeeding tubes on strong signals, thus introducing additional distortion. In fairness, it should be said that in many cases, even with low ratio transformers, the operator of the set is at fault in working the entire amplifier beyond its capacity on powerful local signals.

Grid leaks are sometimes placed across the secondaries of high ratio transformers to limit distortion and overloading. Fig. 4 shows the effect of a 0.25 megohm grid leak across the secondary of a 5 to 1 transformer working between UV-201-A vacuum tubes. It is evident that virtually the same characteristic could be secured by the use of a well-designed 2.7 to 1 transformer which could be constructed at lower cost.

Another transformer attachment frequently met with is a condenser ranging in capacity from 0.00025 to 0.006 M. F. shunted across the secondary either alone or with a grid leak in parallel. The effect of even small capacities alone so located is shown in Fig. 5, where the reduction in amplification of the higher frequencies due to shunts of 0.00015 and 0.0003 M. F. is shown. Of course, with the larger values of capacity mentioned, the effects are much more pronounced than these shown, the higher frequencies being almost entirely suppressed. The resulting reception is unnatural and "drummy" in tone. It is unsatisfactory to the musical listener because true tone values are destroyed and identification of orchestral instruments made difficult if not impossible in some cases. In fact, the higher notes of such instruments as the piccolo, for example, may be entirely filtered out. On the other hand, such reception is sometimes preferred by the nonmusical listener because of the artificial "softness" of tone caused by the suppression of the higher frequencies. This sort of reception is, of course, inherent in some types of reflex circuits which employ by-pass condensers of fairly large capacity across the secondaries of the audio transformers.

Negative biasing of the grids of amplifier tubes will here be referred to chiefly with respect to its effect upon transformer amplification. When the grid of a vacuum tube is made positive with respect to the filament, current will flow in the grid-filament circuit. If, in a transformer coupled amplifier, this takes place (on account either of too high a signal voltage or too low a biasing voltage) current will be caused to flow in the secondary of the transformer and reduction of amplification will occur due to voltage drop in the transformer and in the plate resistance of the preceding tube.

This condition is shown in Fig. 6, where the transformer amplifica-

tion at a single frequency is plotted against voltage impressed on the input circuit. A UV-201-A tube and rather low values of plate battery and grid bias voltage were used, and it will be noted that under these conditions, a satisfactory signal from a loud speaker in the tube output circuit may not be obtained without causing the grid to take current. When the latter condition occurs amplification is not only reduced as shown, but distortion takes place due to the flattening off of the positive half-waves of the grid-filament voltage.

The same phenomenon is illustrated in another way by the curves of Fig. 7. Here the variation in transformer amplification with change in negative grid bias is shown for two 1000 cycle signals; 0.01 volt impressed (E<sub>1</sub>) giving a fair signal on a head set connected in the tube output circuit, while two volts impressed gave a moderate loud speaker signal. A UV-201-A tube with 100-volt plate battery was used.

It will be noted that a negative bias of nearly ten volts was required to secure full transformer amplification at the higher signal voltage, but it should not be inferred that such a large bias may be used without causing distortion due to overrunning the lower bend of the tube characteristic. It is evident that very powerful loud speaker signals may not be obtained in the output circuit of any ordinary receiving tube without more or less overloading of the tube.

The drop in amplification due to grid current is common to all types of intertube transformers, those of higher ratio naturally exhibiting the more sharply falling characteristic.

Reference in published articles has sometimes been made to distortion in amplifying transformers being due to core saturation on strong signals. Theoretical and experimental investigation, however, indicates that the magnetic flux in the core due to the DC plate current is far greater than that due to the alternating signal current. The ratio between the maximum flux caused even by a low frequency signal current of the greatest magnitude likely to flow in the primary, and the flux due to the direct plate current of an ordinary receiving tube is on the order of 3 to 100, and, in most audio transformers, the maximum flux density due to both currents combined is well below saturation.

*(This is the first part of Mr. Olney's very valuable treatise on audio-frequency transformers. The second and last part of the paper will be printed in next month's issue of "Radio in the Home.")*

### Editorially Speaking

(Continued From Page 8)

possible under our present knowledge of radio and of manufacturing methods.

We have more losses in coils than we have in condensers, and this problem is being attacked by many very fine experimenters. There is no question that it will soon be solved. The modern basket woven coil of number 18 or number 14 wire is so far superior to the old type coil wound upon any kind of molded material that there is absolutely no comparison between the two.

A little further improvement in coils—a further lowering of the losses which are in them now—combined with our modern fine condensers will make the set of next year just about 100 per cent better than was the set of last year.

Low loss isn't bunk! The man who thinks it is is the one who is being fooled.



## Five Points of Radio Quality All Developed to the Utmost Degree in

## Air-Way Receiving Sets

Tone, Selectivity, Distance, Volume and Appearance are the five fundamental requirements of radio receiving sets to meet the demands of the buying public, and render satisfactory profits to the dealer.

Air-Way Receiving Sets are designed to and do meet these requirements to the satisfaction of the most discriminating buyer.

Their appearance attracts the buyer's attention and their performance meets his approval. Consequently they are satisfactory and profitable to the dealer, because they sell easily and stay sold, without the necessity of continuous service to keep them in satisfactory operation.

The three designs of the Air-Way line, Models 41, 51 and 52, meet all market demands.

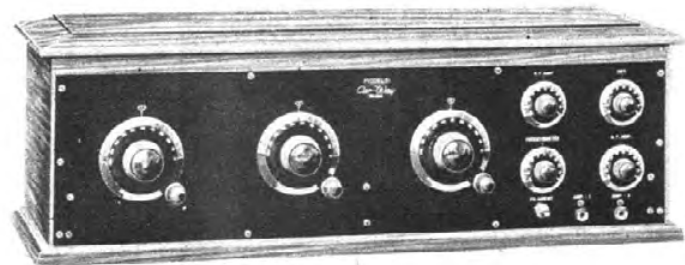

Model 51

Model 51 is a five-tube, tuned radio-frequency set embodying the latest developments in this type of receiver, and includes such strictly up-to-date elements as Spider-web coils, low-loss condensers, etc.

It is the ideal set for the D-X fan who wants to pick up stations all over North America but still demands reception with pleasant audibility and clarity of tone.

Mounted in a five-ply walnut cabinet of attractive design and handsome finish.

Price, \$125.00

Model 52 is practically the same as Model 51, except that the arrangement of parts is changed to fit one of the most attractive console type cabinets ever built.

In the cabinet is ample space for all batteries and other equipment and a built-in loud speaker with Thorola unit, making this an outfit to meet the discriminating requirements of the most fastidious.

Price, \$375.00

A four-tube set with one stage of tuned radio frequency, detector, and two stages of audio-frequency amplification that meets all the requirements of the buyer of modest means.

We offer this set for the consideration of the dealer and buyer as absolutely the best radio value now on the market; in which is combined coast-to-coast reception, perfect tone qualities and the utmost simplicity of tuning in connection with the required degree of selectivity.

Model 41 is attractive in appearance, being installed in a five-ply black walnut case and the dials and fittings are of highest quality and attractive in design.

Price, \$65.00

We invite correspondence from every established radio dealer, regardless of the lines he may now be handling, and have a most attractive proposition to offer.

Write for it today. You can't afford to overlook this proposition.

**AIR-WAY ELECTRIC APPLIANCE CORP.**  
Toledo, Ohio

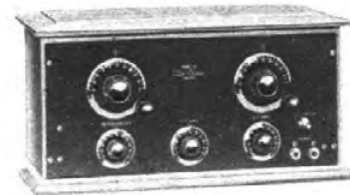

Model 41

# A RECORD! 9600 MILES with a B-T LOW LOSS TUNER

B-T Lifetime Condensers		
Type	Mmf.	Price
L-7	125	\$4.25
L-11	250	4.50
L-23	500	5.00
L-35	750	6.90

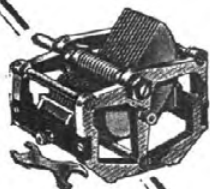

Wherever you go you hear it! Men who know say that B-T'S new Low-Loss Condensers and Inductances are the finest ever. They back up their statements with reports of remarkable performance. Read some of them below.

Radio 2WR, Arthur G. Wester, Assistant Division Manager of Hudson Division, American Radio Relay League, wrote us as follows: "Having obtained one of your new Short-Wave Tuners, I would like to mention results obtained. New Zealand 4AA on 80 meters was copied on November 13 steadily from 6:16 to 6:39 A. M., E. S. T. The estimated distance is 9600 miles. Mexican BX was worked from this station on November 15 and not one word was missed. Numerous other stations from all over the United States have been copied, including 6CTO, 6BNY, 6AME, 6ADT and 6BDT."

R. A. Bradley, Technical Editor of Wireless Age, New York City, says: "The results I have obtained with your tuner and transformer have never been equalled by myself nor my associates. The selectivity of this receiver was greater than any I have ever operated, and this I attribute entirely to the coupler and condenser used. The adjustable coupling on your low-loss tuner is one of the most valuable things that has been added to the regenerative type tuner." (See Dec. Wireless Age for hook-up, or write B-T.)

Radio 9ZA, Chicago, Illinois, received English, French and Mexican stations, both code and voice, in testing with one of our Short-Wave, Low-Loss Tuners.

Don't fail to see these parts at your dealers today. Our 40-page book, "Better Tuning," contains details of this advanced apparatus, hook-ups, construction, tuning and general information. Sent postpaid for 10c.

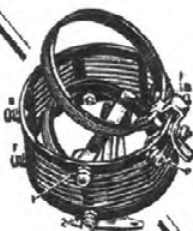

B-T Low-Loss Tuners  
Made for Broadcast or  
Short Wave Work  
Ranges Covered with B-T  
Lifetime Condenser (L-11)  
Type B 200 to 565  
meters .....\$5.00  
Type SW 50 to 150  
meters .....\$5.00

**Bremer-Tully Mfg. Co.**  
"Pioneers of Better Tuning"  
532 S. CANAL ST. CHICAGO, ILL.

## Harkness Answers Questions on the Reflex and Counterflex Circuits

(Continued From Page 20)

and generally more satisfactory method is to use an indoor antenna for the reception of local stations, and a high outdoor aerial for the reception of distant stations, only when the locals are not operating.

To increase the selectivity without decreasing audibility, it is necessary to add a tuning control which means that you will have to turn three dials to tune the receiver instead of two. Fig. 1 shows one of the simplest arrangements for increasing selectivity by tuning the antenna circuit. The diagram is self-explanatory. The parts needed are:

- One 23-plate variable condenser.
- One 2 1/2 or 3 inch coil wound with sixty turns of wire.
- 2 Binding posts.
- 1 Single pole, single-throw switch.
- 1 Dial.

Mount these parts on a small panel, help upright by a baseboard. The

this coil. The antenna should be attached to the clip which gives the best results. A long antenna requires less turns on the primary of T1 than a short antenna; hence the tap.

It is true that the Chelton midget condenser does not have sufficient capacity to control self-oscillation in the counterflex. The Harkness counterflex vernier condenser was designed for this purpose and covers the correct range of capacity. I would suggest that you use it. The shorter aerial will not help this condition; it will make it worse. A short aerial has less resistance than a long aerial; consequently self-oscillation will be more easily set up when you use a shorter aerial and you will need a higher counteracting condenser to offset the decrease of resistance.

C. A. Barron, of 620 Torresdale avenue, Philadelphia, writes an interesting letter. His experiences may benefit you.

"I built your new set," he writes,

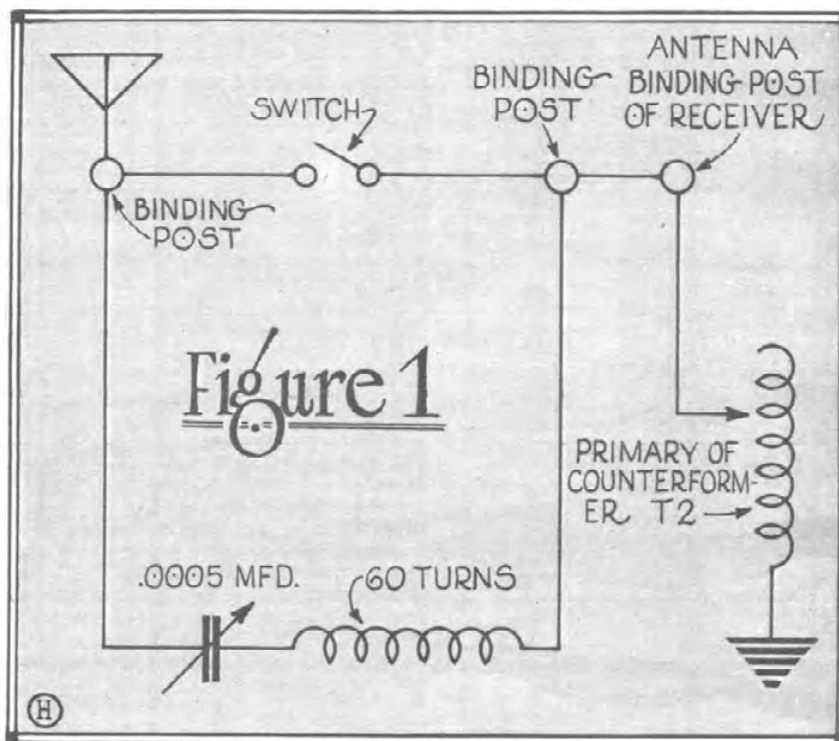

coil can be attached to rear of the variable condenser to save space, but should be mounted so that it is at right angles to the transformer of Counterformer T1. Wire the parts together as shown in the diagram and then set the unit alongside your receiver, on the left-hand side. Transfer the antenna connection from the receiver to the tuning unit and connect the opposite side of the unit to the antenna binding post of the receiver, as shown in Fig. 1.

You will find that this helps your selectivity and, instead of reducing audibility, it actually increases the audibility. Often you will not need the extra selectivity, in which case you can close the switch and short-circuit the tuning unit, thereby avoiding the necessity for tuning three circuits. When tuning in distant stations it would be advisable to keep the switch closed until a station is located with the two tuning dials of the receiver, then opening the switch and tuning the antenna circuit to increase audibility.

Replying to the other questions brought up in this letter, the answers are as follows:

There are two clips on Counterformer T1, one clip being connected to the end of the primary coil and the other clip connected to a tap on

"and it is great. When I hooked it up it worked at once. Wonderful tone quality. Tested it according to your directions and it howls at all frequencies. All jake? Not quite. I did not get those thousand-mile stations you corralled last August. I made an effort to get them by changing the set and had an experience so interesting that I want to tell you about it because others are almost certain to have the same difficulties that I got into because of different ideas of wiring.

"The power of the set was so easily controlled by the primary tap and the filament rheostat that I decided to cut out the first telephone jack, thereby reducing the inductance, capacity losses, hysteresis, etc., etc., of four long leads and in addition improve the appearance of the set. After I did this—gloom!

"Everything was right. Signals came in, but only average and no longer any howling at any frequency when the plates of the counterflex were out. You would know at once what to do, but it took me an unhappy half hour before I got an idea. I was about to hook up the jack again but decided that should not be necessary. I then considered that as I had probably reduced capacity (as well as some other bad things) with these

### 9 Points of Superiority

- 1-Soldered brass plates.
- 2-Stator plates shaped for easy tuning on low waves.
- 3-Adjustable ball-bearing rotor shaft. Metal end-plates.
- 4-Soldered clock-spring pig-tail.
- 5-Losses too small to measure.
- 6-Rugged construction.
- 7-Micrometer Vernier moves all plates; no back-lash.
- 8-Takes any size dial.
- 9-The product of 14 years experience, making precision instruments.



New Model "C"

U.S. and Foreign Patents.

## For BETTER Radio

HAMMARLUND CONDENSERS, from the first, have been designed for better radio.

The New Model "C" more nearly approaches perfection than any similar instrument the engineering world has produced.

Look for Hammarlund Condensers in the receiver you buy. Use only Hammarlund Condensers in the receiver you build.

All capacities; plain and vernier. Sold by the better radio dealers.

Write for Descriptive Folder

HAMMARLUND MFG. CO.  
424-438 West 33rd Street, New York

For Better Radio  
**Hammarlund**  
PRECISION  
CONDENSER

wires, I should add some to the secondary of the first audio transformer. I had a .00025 grid condenser handy so I used that and it worked at once. The blessed howling returned with re-enforcement and now I can see the necessity for the counterswitch which before was unnecessary.

"Everything else being right, the best results with this set are going to be obtained by a careful selection of this secondary condenser."

I quote this letter to bring out the importance of experimenting with the values of the by-pass condensers of the counterflex. Just as it is impossible for me to give the constants of the radio-frequency transformers except with a particular make of condenser, so it is impossible for me to give the exact value of the by-pass condensers for different types of audio-frequency transformers, variable condensers, etc. If a Counterflex is built with the same parts which I use only one by-pass condenser is needed, across the secondary of the reflex transformer, and this condenser has a capacity of .0001 Mfd. But if different apparatus is used the resistance of the circuits may be greater or less and it is necessary to experiment with the values of the by-pass condensers. In this respect I have already given instructions for testing the Counterflex for efficiency in the October and January issues.

Gordon A. Golt, of 166 Pine ave., E., Montreal, Canada, asks the following questions, the answers being given under each question:

**Question No. 1**—Would it be all right to use two condensers with 17 plates each? If not, how many plates?

**Answer:** If the condensers each have a maximum capacity of not less than .00025 Mfd. and not more than .0003 Mfd. they can be used with transformers wound to the following specifications:

Primary, T1—Ten turns with a tap at the fifth turn.

Secondary, T1—Sixty turns.

Primary, T2—30 turns.

Secondary, T2—60 turns.

I may mention that, by an oversight, I gave the wrong specifications for these transformers in the November issue. The above constants are correct, as used in the manufactured Countercoils.

**Question No. 2**—Is it good to use a 3-plate vernier condenser for the Counterdon? If not, how many?

**Answer:** It depends on the size of the plates. The standard Counterdon has only three plates but the plates are large and the maximum capacity is higher than the usual vernier condenser.

**Question No. 3**—If I use three U. V. 199 tubes what voltage must the "A" battery be?

**Answer:** Connect three 1½-volt dry cells in series, giving a total potential difference of 1½ volts.

**Question No. 4**—Is it possible to use a "C" battery and, if so, how many volts?

**Answer:** Yes. The circuit is given in Fig. 2. The C battery should be from 1½ to 4½ volts, depending upon the plate voltage.

Frank L. Hilweck, of Louisville, Kentucky, and a host of others, ask the following question:

**Question**—How many turns on transformers T1 and T2 when using .0005 Mfd. (23-plate) condensers?

**Answer:** The approximate constants are as follows:

Primary, T1—Ten turns with tap at fifth turn.

Secondary, T1—Forty-five turns.

Primary, T2—Twenty-five turns.

Secondary, T2—Fifty turns.

By comparing these constants with those given for lower capacity condensers it will be evident that a receiver using .00025 condensers is much more efficient. If you use .0005 Mfd. condensers you need not expect as high audibility or selectivity and

you must experiment with the values of the by-pass condensers to balance up your set.

P. S. Edwards, of Georgetown, S. C., asks:

**Question**—How is Counterformer T2 connected? As shown in Fig. 1 of your article in the October issue, or as shown in Fig. 3?

**Answer:** There is no difference between these two diagrams although, I am sorry to say, some confusion seems to have been caused by the fact that the manufactured Counterformer T2 has its terminals numbered in such a way that there appears to be a difference. The numbers given in Fig. 3 in the October issue correspond with the numbers on the label inside the Counterformer. The following explanation will probably make it clear:

**Terminal No. 1**—End of primary coil, goes to telephones or primary of second audio transformer.

**Terminal No. 2**—Beginning of primary coil, goes to plate of reflex tube.

**Terminal No. 3**—Beginning of secondary coil, goes to grid condenser of detector tube.

**Terminal No. 4**—End of secondary coil, goes to filament.

And now, while there are a great many other questions which have been asked, they are not of such general interest as those which I have selected. I have received numerous requests to publish the standard 2-tube Harkness Reflex circuit. This is shown in Fig. 3.

If you have questions to ask which are not covered here I shall do my best to answer them by mail. I cannot, however, be of any assistance if you do not make your questions specific and, unless you wish me to answer in the form of an article in this magazine on some subject which you wish cleared up, the questions must be of such a nature that it is possible to answer them within the limitations of a letter.

### Polishing the Door Plate

(Continued From Page 23)

to keep track of the finest artists who appear constantly at the studio in other programs. If he finds that he needs a tenor, or an organ solo, or an orchestra, he knows exactly where he may obtain the finest in the city. He is himself a thorough musician and arranges not only these Packard programs, but also those for the Eveready, A. and P., and numerous others of the regular features. He works out the entire plan for the musical presentations, and in the case of the Packard programs especially, he has accomplished some remarkable results.

You must have noticed the delightful effects of movement that come in these talks. For instance, Mr. Cooley says they are approaching a church, and an organ is being played. Then you hear the organ in the distance—it grows louder and louder—you are outside the church—you pass on and it fades away. You drive down to the shore of Moosehead Bay. A canoe comes silently by. The occupants begin to play a victrola, which approaches, passes by, and then becomes only a faint strain in the moonlight as the canoe goes round the bend. Mr. Chatfield is the first man to have perfected this impression of motion in a musical rendition. After each presentation he watches the mail carefully to see how it went out and how it was received, and he has every reason to be pleased with the results.

In a talk that covered a trip from the Berkshires to Albany, down the Hudson Valley over Bear Mountain Bridge to New York, the following opportunities for musical interpolations were found:

"After pausing for the view (of the State Capitol), we run into Albany and stop at the Ten Eyck

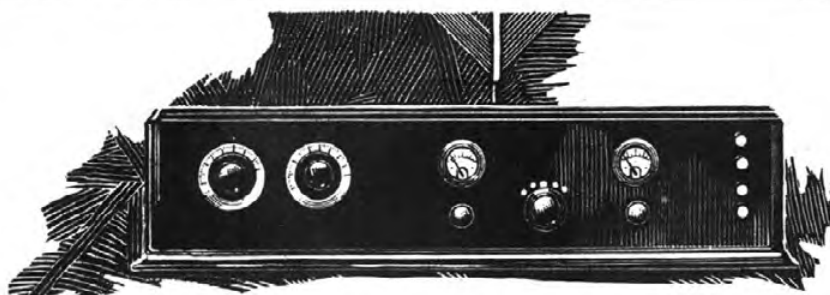

## The Most Lasting Front for a Radio Set!

**FORMICA** is the most widely accepted material for radio panels, because it is the best and most uniformly efficient insulator; because it is by far the best looking material; because it is mechanically strong, and because all of its qualities of appearance, strength and insulating ability are as nearly permanent as anything made by man can be.

The materials of which Formica is made are chemically inert—they are not in any way affected by weather or time. They will never craze or crack as the best varnish or lacquer ultimately will do. They never deteriorate.

With few exceptions all the leading set makers use Formica because they know it is permanently satisfactory.

Write for booklet, "What Formica Is."

### THE FORMICA INSULATION COMPANY

4654 Spring Grove Avenue, Cincinnati, Ohio

#### SALES OFFICES

50 Church Street.....New York, N. Y.	289 Victoria St...Toronto, Ontario, Can.
9 South Clinton St.....Chicago, Ill.	1026 Second Avenue...Minneapolis, Minn.
516 Caxton Bldg.....Cleveland, Ohio	1210 Arch Street.....Philadelphia, Pa.
1142 Granite Bldg.....Rochester, N. Y.	708 Title Bldg.....Baltimore, Md.
422 First Avenue.....Pittsburgh, Pa.	585 Mission Street...San Francisco, Cal.
6 Beacon Street.....Boston, Mass.	419 Ohio Building.....Toledo, Ohio
55 Calle Obispo.....Habana, Cuba	309 Plymouth Bldg...New Haven, Conn.
	Whitney Central Bldg...New Orleans, La.

- 1 Formica is used by 125 leading set makers. Ninety per cent of the sets in the shows this year had Formica parts.
- 2 Formica will last forever.
- 3 Formica in appearance is the finest of all panel materials and always remains so.
- 4 Formica electrical qualities of every kind far exceed any possible requirement.
- 5 Formica has high mechanical strength and will not break in use.
- 6 Formica will not sag from heat or cold flow under pressure. It retains its dimensions. Everything you fasten to it stays tight and precisely where you put it.
- 7 Formica panels are sold in neat craft paper envelopes that assure you that you are getting the genuine.
- 8 Formica is one of the most widely used and most generally approved materials in radio.

# FORMICA

Made from Anhydrous Bakelite Resins  
SHEETS TUBES RODS

Hear the Formica band every Wednesday evening from 9 to 10 Central Standard Time over WLW.

## Why Airtrons Multiply Radio Enjoyment

YOU will discover a new thrill and enjoyment from your radio set when you use Airtron Tubes. Built with exactness and precision, with every effort bent toward greatest efficiency, the Airtron provides the most volume consistent with absolute purity of tone. In stamina, in clarity and sensitiveness, Airtrons will outperform any tube at anything near its price. Highly endorsed by radio experts.

List Price \$4.00—Fully Guaranteed

Type 200—6 Volt—1 Amp. Detector	Type 12—1½ Volt—25 Amp. Det. & Ampl.
Type 201A—5 Volt—25 Amp. Det. & Ampl.	Type 199—¼ Volt—.06 Amp. Det. & Ampl.

Sold by all dealers, or shipped C. O. D. direct by parcel post. Mention type when ordering.

H. & H. RADIO CO.  
Dept. 103, 514 Clinton Avenue, Newark, N. J.



DEALERS—Write for discounts

# AIRTRON

RADIO TUBES



## David Grimes' Choice

The new Grimes 3XP Inverse Duplex circuit has established a new standard in radio reception. Where great discrimination was shown in choosing parts, it is significant that he chose

# Jefferson Transformers

Just one more instance where Jefferson superiority was demonstrated by comparison. David Grimes is only one of the many radio authorities the world over to recognize the superiority of Jefferson performance.

Jefferson Transformers meet matched construction specifications.

Sold through the better dealers and distributors.

### Jefferson Electric Mfg. Co.

432 S. Green St. Chicago, Ill.

#### Manufacturers of

Radio Transformers  
Bell-Ringing Transformers  
Sign-Lighting Transformers  
Automobile Ignition Coils  
Jump Spark, Make and Break Coils  
Auto Transformers  
Testing Instruments  
Toy Transformers  
Furnace and Oil Burner Transformers  
Oil Burner Ignition Coils

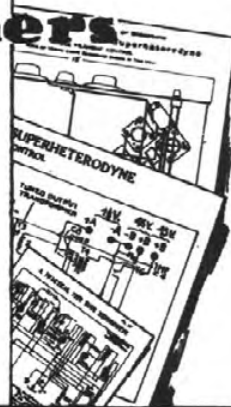

### Send for these hookups

Grimes 3XP Inverse Duplex, Jefferson Baby Grand Six-Tube Super-Heterodyne, Jefferson Eight-Tube Super-Heterodyne. Any of these sent on receipt of 5 cents in stamps to cover postage.

## RADIO DEALERS!

The new plan of publishing PICTORIAL DIAGRAMS of hook-ups in *RADIO IN THE HOME* enables even a novice to build the most complicated sets. These diagrams show every step in the wiring operation. This service creates good will and additional sales for the dealer.

The high standard maintained in the advertising columns of *RADIO IN THE HOME*, where only quality apparatus which we have tested is accepted for these columns, guards the fan against using inferior apparatus. This service helps the dealer increase the sale of quality apparatus and gain the good will of the radio fan.

Cash in on this good will and additional sales by bringing *RADIO IN THE HOME* to the attention of your radio fan customers.

For full information write to

## RADIO IN THE HOME

608 Chestnut St., Phila., Pa.

Hotel, which we make our headquarters. In the evening our party enjoyed dancing to the music of their fine orchestra." Here we have a Ten Eyck dance number, "Strolling," played by an orchestra selected by Mr. Chatfield.

To continue in the same talk, they pass along the Storm King road. "Suddenly we hear music. Bill, the chauffeur, stops the car and we see the cadets marching across the West Point parade grounds." Then follows the West Point "Triumphal March." This talk also included the unusual feature of having the car stop and take on a friend of Mr. Cooley's, who was Mr. Wilson Fitch Smith, the chief engineer of the Bear Mountain Bridge. There is then to be heard a question and answer conversation between the two men as they approach the new bridge, giving the listeners in this expert's inside information about his wonderful piece of engineering. The effect of having the car stop, etc., is splendid, and adds immeasurably to the talk value.

One of the really unique uses of music came in the talk of November 20, which was a trip from New York over the Lackawanna Trail to the Finger Lake Region. This covers a region rich in Indian folklore, so Oskenton, a Mohawk Indian baritone, was brought in to sing the "American Indian War Song," "The Indian Invocation" and various other native selections in the course of the lecture.

Now all of this is delightful entertainment for the radio audience, but as it is after all meant for publicity for the firms involved, how do they obtain that publicity? We all know that they do not talk directly about their commodities over the air, as the only direct advertising that is favorably received is that of the printed page.

Well, they do it very adroitly. When the "Happiness Candy Boys" are ready to begin their program, the announcer introduces them like this:

"'Happiness,' says Sir Philip Sidney, 'is a sunbeam, which may pass through a thousand bosoms without losing a particle of its original ray.' And radio waves, like happiness, may go on and on, from heart to heart, and from home to home, bringing their happy messages to millions of unseen listeners. On each Friday evening at this hour the Happiness Candy Stores have engaged the facilities of this station to broadcast happiness through the inimitable 'Happiness Candy Boys'—Billy Jones and Earnest Hare."

And as they close:

"You have been listening to the Happiness Candy Boys, who each Friday at this hour use the facilities of this station to broadcast to you for the Happiness Candy Stores a message of fun and happiness. If they have pleased you, write a little note of appreciation. It will make them happy to know that they have given you pleasure. Address the Happiness Candy Boys, care of Station WEAJ, 195 Broadway, New York City. If you wish, you may obtain special radio applause cards with pictures of the Happiness Candy Boys in any Happiness Candy Store."

Then the "Happiness Boys" sing their little "How Do You Do" song, introducing themselves to the radio audience, and two or three times during their program they repeat their identity for the sake of those who have just begun to listen in.

The Packard talk, after a similar introduction, starts with two blasts of the horn: "We're off!" Then in the course of the talk such phrases as these occur:

"Leaving New York we cross Fort Lee Ferry, and landing, run our comfortable Packard up the hill of the Palisades.

"From here we begin to ascend the steep grades of the Pocono Mountains, our Packard engine taking it without a murmur, and the sturdy car glides gracefully over the rises and around the curves.

"From here we go down some steep grades and sharp turns—thankful again for the security of our four-wheel grips and the careful driving of Bill."

In this way all the good points of the car are brought out very quietly and without any dwelling on this publicity end of it.

"If you can get a more direct selling than that, I don't know it," says Mr. Gunnison. "If you can get a tooth pulled without knowing it, all the better—if you can bring out the best points of a car without seeming to do so, all the better. For instance, how much more convincing it is, instead of talking directly about how smoothly the engine runs, merely to mention that as the car drove noiselessly down to the brink of Moosehead Lake, the lapping of the waves and the distant strains of music were the only sounds to be heard as the canoe approached.

And then he adds what really sums up the entire question:

"Like any advertising or publicity media, you can make a good story or a bad story of it—you can handle it well or badly. You have an opportunity to make a strong and interesting appeal or a complete failure, as in newspaper copy you can make an excellent lay-out and forceful copy, or make it a weak failure. On the air you can have an interesting program with good talent, and use real sales psychology, or an uninteresting idea which will lose you the tremendous force which is the radio audience. We think we have had the radio audience's approval in these two widely divergent angles, because there has been a subtle appeal to both potential fields."

## Reception With the Flewelling Circuit

(Continued From Page 25)

Fig. 5 is one from a distant station. An interesting way of illustrating how such things as are shown on these curves affect your own receiver is the following: Refer to Figure 5 and note the time shown on the bottom line, i. e., from 7:30 P. M. to 8:25 P. M. Imagine yourself tuning your set for WCAP at 7:55 P. M. According to the curve you would get them "wonderfully—easy as could be." But suppose you were tuning for them at 8:05 P. M. Then, according to the curve, you'd "guess they're not on tonight" or "this receiver is no good." Now you know why I have asked for patience in handling your receiver.

A little study of these curves and my line of thought above will readily show that we must take advantage of everything that we can to aid our receiver. While the Flewelling receiver is said to operate without any energy collector, strictly speaking this is not so, because the wiring and coils in the set itself are the energy collectors used.

If, then, you desire to collect more energy for greater volume or distance you must add to this wiring by using an antenna. This might cause the super part of it to stop operating, but if done as recommended in this article, an antenna will be of help and still not affect the operation of the super part nor bother one's neighbors if the little fixed plates are kept a sufficient distance apart.

My telephone and my mail are showing me that this circuit is causing its usual furor, and it is indeed gratifying to receive so many reports of wonderful reception and delightful results—or that it does not work at all!!!

# "Just Write Jean Sargent"

By G. P. ALLEN

New England Representative of "Radio in the Home"

DO YOU want to know how Columbus felt when he discovered America? Tune in some night on WNAC and, if you are fortunate, you will hear a woman's voice that not only is pleasing but which also carries with it a conviction of sincerity—a combination which is rare in radio.

Then, if you wish an added pleasure, the next time you are in Boston stop at WNAC and meet Jean Sargent.

Unfortunately for us she is the secretary of the station and in this capacity she acts as publicity agent also. While she would give you all the pictures and information about WNAC you wanted, she is very unwilling to say much, or give you any pictures of Jean Sargent.

Lacking a "close-up" you naturally would like a description of Jean Sargent. Just there is where my command of English fails me. To call her young would bring to mind the flapper type. To call her middle-aged would do her a grave injustice, nor is she a combination of the two.

Jean Sargent is Jean Sargent—one of the most charming and inter-

esting people I have met in a long while. With considerable reluctance she did give me a picture of the reception room, which shows her seated at her desk just as you would see her if you dropped in some day at WNAC.

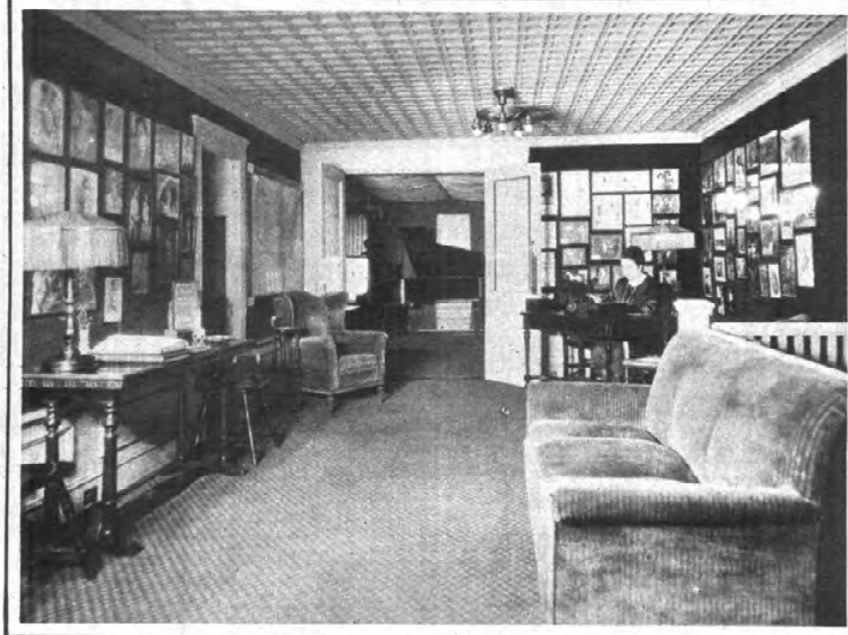

Jean Sargent at her desk in Station WNAC, Boston

feature on WNAC's daily program. You may be a bride entertaining your "in-laws" for the first time and have grave doubts as to what is proper in certain details—"Just write Jean Sargent" and you will learn via radio. Do you wish help in planning a wardrobe for children leaving for school? Write Jean Sargent!

Here, it is time to stop and explain fully that these talks are far removed from the Sob Sister Sunday supplement stuff and do not even fall in the same class as the syndicated "Household Helps."

As I said before, Jean Sargent is willing to talk about any one but herself. However, between answering the phone and talking to her assistants she did let a few facts slip out.

To listen to her over the radio one gets the idea of academic honors, as her diction is so pure, her selection of subjects so apt, and her choice of readings so fit for her audience. Jean Sargent's family traveled so constantly that it was impossible for her to attend school. Under the supervision of her father, a man of splendid education, tutors who traveled with them gave the necessary

instruction. As she progressed the tutors were changed to meet her needs. Upon the death of her father, his partners continued her education, eventually taking her into business with them. She tells of traveling all over the world, buying raw materials with them and also of later going out and selling the finished product. Many a business man of Boston is glad of a few moments' conversation with her to help solve a knotty problem.

Jean Sargent at first said that she had no hobbies and that her evenings (when she has one free) are spent in reading and sewing. Just after she had answered a phone call, she let slip the remark that she "would give a million dollars if Mr. Shepard would give me a chance to learn to operate the transmitter upstairs."

Before Christmas, Jean Sargent extended her activities to include the men. Although WNAC is now a "500 watter," I fear that some of you may not have been able to catch her voice. She has some very definite

Jean Sargent at first said that she had no hobbies and that her evenings (when she has one free) are spent in reading and sewing. Just after she had answered a phone call, she let slip the remark that she "would give a million dollars if Mr. Shepard would give me a chance to learn to operate the transmitter upstairs."

Before Christmas, Jean Sargent extended her activities to include the men. Although WNAC is now a "500 watter," I fear that some of you may not have been able to catch her voice. She has some very definite

The WNAC Women's Club was organized with Jean Sargent in charge of the programs. It was necessary for her to speak from time to time on various features of the program and finally she has become a regular

(Continued on Page 61)



## One Dial

But one dial to tune, no unsightly outside Antenna, no Ground to bother with. It's easy to get Volume, Distance and Selectivity with the

## MODERN Super-Six "REFLEX"

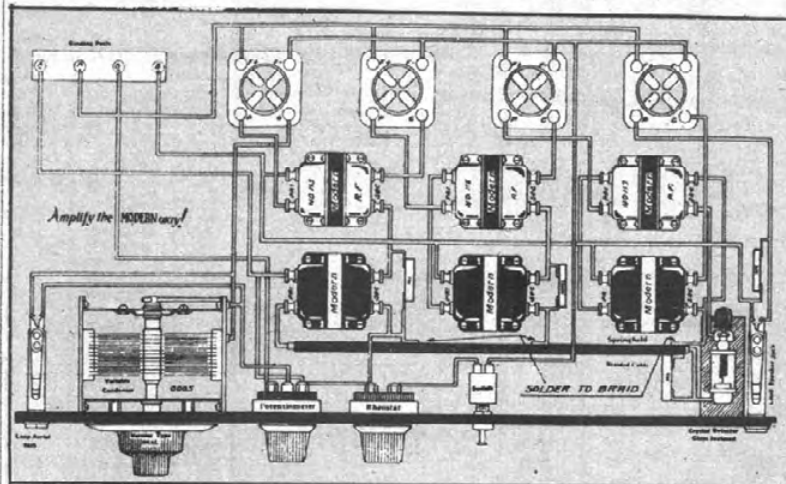

This set is easy to build and your friends will marvel at the results from this set. Full size wiring diagram and complete constructional bulletin of above circuit sent on receipt of 4 cents in stamps. Write for it today.

### THE MODERN ELECTRIC MFG. CO. TOLEDO, OHIO

World's Largest Transformer Manufacturers Making Transformers Exclusively for Radio Purposes.

MODERN Engineers have steadfastly refused to cheapen their product to meet the requirements of some set manufacturers. When you buy MODERNS in a set you'll know price was not the consideration for the manufacturer's choice of MODERN Transformers.



## Buy only parts needed for RUBICON Super Set



Kits to build 8 or 9 tube sets, \$23.50 to \$138.50.

You can use many of your present parts in building the latest model Rubicon Super. From your dealer or from us, get a list of parts needed. Then select the Rubicon Kit that fits your purposes—complete to the last detail, or only the things you want at a saving around 60%.

Postcard Brings Folder

### RUBICON COMPANY

918 Victory Bdg., Philadelphia, Pa.

## GRIMES

and His Famous

## INVERSE-DUPLEX SYSTEM

are found exclusively in "Radio in the Home." David Grimes is one of our Associate Editors and writes for no other publication.

# Earn \$50 to \$200 a Week in RADIO

You can! Hundreds of ambitious men are already earning thousands of dollars in this wonderful new industry—you, too, can get your share. Mail coupon below for Free Book, which describes fully the amazing money-making opportunities in Radio and tells how YOU can earn from \$5,000 to over \$10,000 a year.

The astounding growth of Radio has created thousands of big money opportunities. Millions of dollars were spent during the past year on Radio, and thousands of young men are needed right now to meet the ever-increasing demand of work.

Men are needed to build, sell and install Radio sets—to design, test, repair—as radio engineers and executives—as operators at land stations and on ships traveling the world over—as operators at the hundreds of broadcasting stations. And these are just a few of the wonderful opportunities.

## Easy to Learn Radio at Home in Spare Time

No matter if you know *nothing* about Radio now, you can quickly become a radio expert by our marvelous new method of practical instruction—instruction which includes all the material for building the latest up-to-date radio apparatus.

Scores of young men who have taken our course are already earning from \$75 to \$200 a week. Merle Wetzel, of Chicago Heights, Ill., advanced from lineman to Radio Engineer, increasing his salary 100% *even while taking our course!* Emmet Welch, right after finishing his training, started earning \$300 a month and expenses. Another graduate is now an operator of a broadcasting station—FWX of Havana, Cuba, and earns \$250 a month. Still another graduate, only 16 years old, is averaging \$70 a week in a radio store.

## Wonderful Opportunities

Hardly a week goes by without our receiving urgent calls for our graduates. "We need the services of a competent Radio Engineer." "We want men with executive ability in addition to radio knowledge to become our local managers." "We require the services of several resident demonstrators"—these are just a few small indications of the great variety of opportunities open to our graduates.

Take advantage of our practical training and the unusual conditions in Radio to step into a big paying position in this wonderful new field. Radio offers you more money than you probably ever dreamed possible—a fascinating, easy work—a chance to travel and see the world if you care to or to take any one of the many radio positions all around you at home. And Radio offers you a glorious future! The National Radio Institute is one of America's Pioneer Radio Schools—established in 1914. Our course is an absolutely complete one which qualifies for a

### Pay Increases Over \$100 a Month

I am averaging a n y - where f r o m \$75 to \$150 a m o n t h more than I was making before enrolling with you. I would not consider \$10,000 too much for the course. (Signed) A. N. Long, 120 No. Main St., Greensburg, Pa.

### Doubles Salary

I can very easily make double the amount of money now than before I enrolled with you. Your course has benefited me approximately \$3,000 over and above what I would have earned had I not taken it. (Signed) T. Winder, 731 Bedford Ave., Grand Junction, Colo.



government first-class commercial license. It gets you the *bigger* paying jobs in Radio.

## Send for FREE RADIO BOOK

Learn more about this tremendous new field and its remarkable opportunities. Learn how you can quickly become a radio expert and make big money in Radio.

We have just prepared a new 32-page booklet which gives a thorough outline of the field of Radio—and describes our amazing practical training in detail.

This Free Book, "Rich Rewards in Radio," will be sent to you without the slightest obligation. Mail coupon for it now! For a short time we are offering a reduced rate to those who enroll at once. Act promptly and save money.



**National Radio Institute**  
Dept. 54CB  
Washington, D. C.

**NATIONAL RADIO INSTITUTE**  
Dept. 54CB, Washington, D. C.

Please send me without the slightest obligation your Free Book, "Rich Rewards in Radio," and full details of your special Free Employment Service. Please write plainly.

Name ..... Age.....  
Address .....  
City ..... State.....

# The Amazing Story of the Radio Ray

(Continued From Page 11)

most complicated of all the ninety-two different kinds of atoms now remaining in our universe is that of uranium, which has a nucleus into which are tightly packed 238 protons and 146 electrons, around which revolve ninety-two planetary electrons distributed systematically in seven concentric shells or spheres. The story of how uranium atoms are constantly and spontaneously exploding

Strange as it may seem the actual size of the atomic nucleus is not appreciably greater than the size of an electron, and the actual bulk of the nucleus and planetary electrons taken together is extremely small compared to the size of the entire atom. Let me read what Professor Millikan in a recent number of Science says in this connection:

"The nucleus of an atom is extraor-

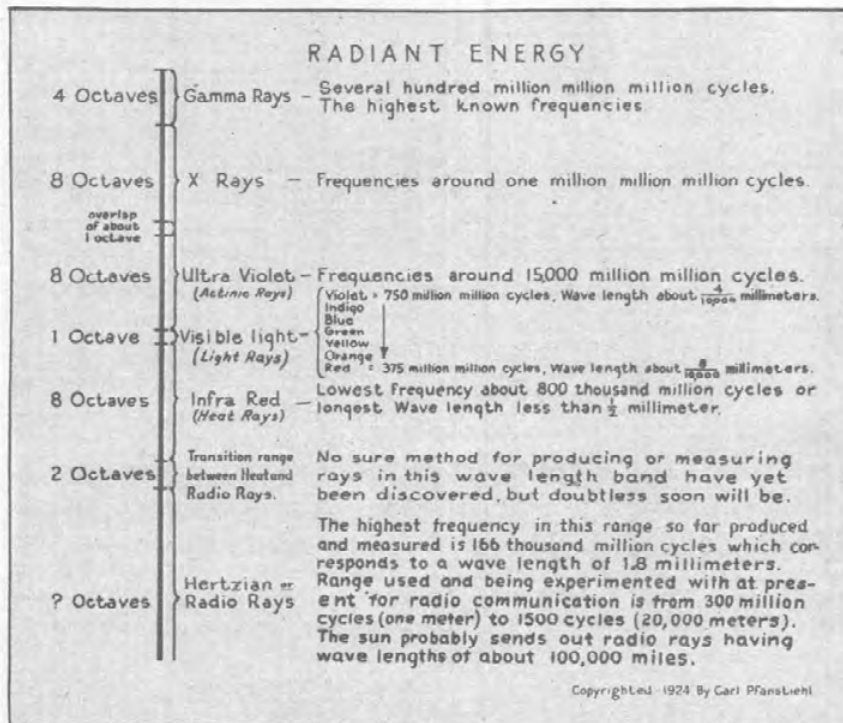

Chart showing the Radiant Energy family. The members differ from each other only in the frequency of emission, or wave length. Note the miserably small range—only one octave—that our eyes respond to as light. The two as yet unexplored octaves between heat and radio rays are particularly interesting, as there are certain theoretical reasons why some very practical results both in the chemical and radio fields are likely to follow the discovery of means for the practical production of rays in this band

and thereby transmuting themselves into the simpler elements and at the same time supplying our world with that necessary commodity we call

dinarily minute, so that if all the dimensions of an atom were magnified ten billion times—a magnification which would make a birdshot swell to the size of the earth and would make the diameter of the atom about one meter—the nucleus on this huge scale of magnification, would not be more than a tenth of a millimeter in diameter—that is, not larger than a mere pin point."

It would seem from this that what we are in the habit of regarding as solid matter is, in reality, mostly empty space.

All electrons, however, are not con-

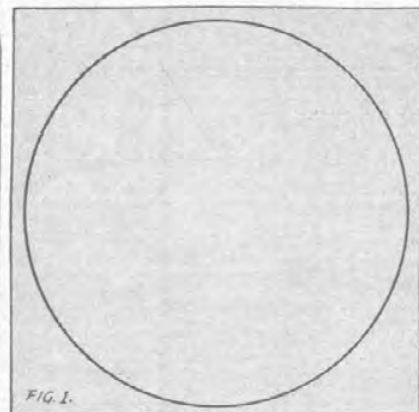

"energy" is most interesting, but time does not permit the telling now.

All electrons, no matter from what element they come, are exactly alike. The same is true of protons. From this it follows that the only difference between an atom of gold and an atom of copper or any other element is in the number and arrangement of its planetary electrons, and the number of protons and electrons there are crammed into the nucleus itself. A proton has been found to weigh 1845 times as much as an electron, therefore the greater part of the mass of an atom is confined in its nucleus.

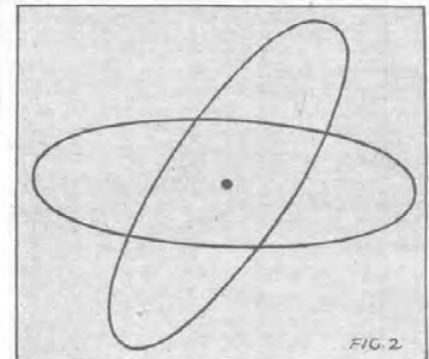

finer or bound to atomic systems, but some are more or less free to roam about between atoms. These free electrons are in continuous and rapid motion, changing their direction con-

# The Best Wave Trap

we know of can be made by any novice in fifteen minutes. A .001 variable condenser, some wire, a salt box or other form—and your set becomes 50 per cent more selective. Full instructions and pictures were given on Page 24 of our issue of April, 1924, under the title:

## "YOU CAN SUPPRESS THAT INTERFERENCE"

If your set is not sufficiently selective, it will pay you to try this wave trap.

Send 10 cents for a copy of the April issue to

Circulation Department

**RADIO IN THE HOME**

608 Chestnut St., Philadelphia

stantly to avoid direct collisions, whenever possible, with other electrons or atomic nuclei. They might well be called the bachelors of the subatomic world! Their average speed, if continued in a straight line, would be about thirty miles per second. They often shoot straight through several atomic systems without a collision, just as a shotgun occasionally can be fired through a flock of geese without hitting any of the birds.

In certain substances called *insulators* the activities of these free elec-

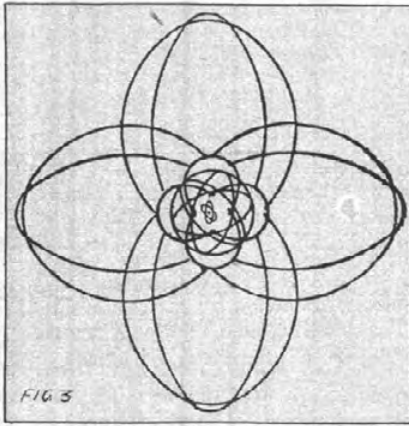

trons are largely confined to a limited space, whereas in other substances known as *conductors* they are able, when properly urged, to work their way with more or less freedom to other parts of the conductor.

When a conductor, such as a copper wire, is properly connected to a battery or other source of electromotive force, the free electrons are impelled to migrate along the wire and an electric current is then said to be flowing through the wire. *An electric current therefore is nothing but a stream of free electrons working their way along a conductor.* To

negative. This was an unfortunate assumption, however, since we now know that the migration of electrons actually occurs in the opposite direction, that is, *from the negative pole to the positive pole.* This explains the apparent inconsistency in connecting the positive pole of the B battery to the plate of a radio tube when it is well known that the electrons actually pass *from the hot filament to the plate.*

It follows from what I have said that these little pieces or grains of electricity are also the building bricks of which all matter is made.

We must leave the structure of matter and electricity now and consider the mysterious phenomenon of energy, which, as I have said, also has its origin within the atom. The particular form of action to which radio transmission belongs is known as "radiant energy." Whenever an electron, whirling around the nucleus inside of an atom, is knocked or jarred out of its normal orbit, a peculiar phenomenon takes place; a certain definite amount of energy known as one "quantum" is shot off

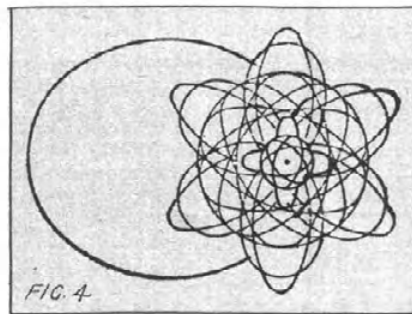

in a straight line into space, and it travels at the uniform speed of 186,000 miles per second. Of course, this happens to countless numbers of atoms simultaneously.

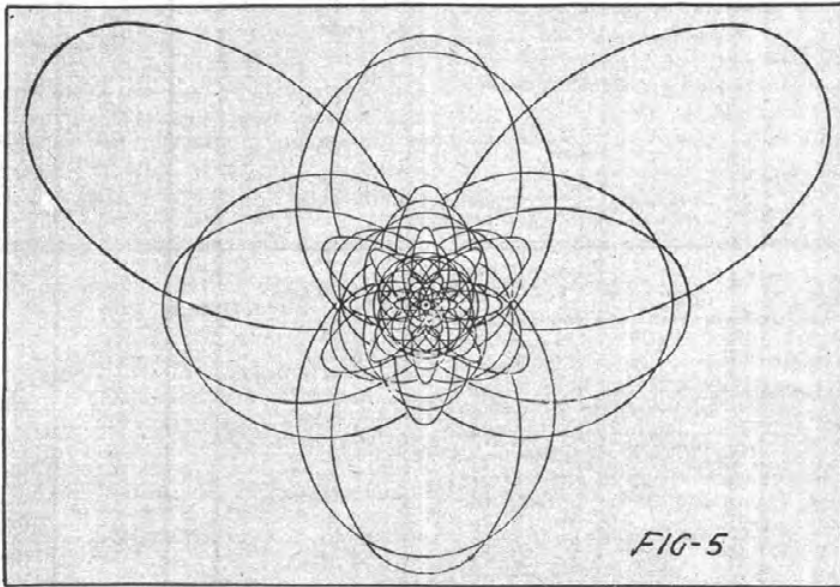

be exact, we should buy electricity for lighting our homes from the central stations by the piece, but this would involve some practical difficulties. If we were to count the actual number of electrons that pass into an ordinary electric light bulb in one second we should have to employ two and one-half million people, each person would have to count electrons at the rate of two per second, and if they all worked constantly day and night, *the job would be completed in twenty thousand years!*

Years before the exact nature of electricity was known, the terms positive and negative were chosen to indicate the direction in which an electric current flowed, which was arbitrarily assumed to be *from the positive to the*

According to the "Planck-Einstein" theory of radiant energy it is the scattering or radiating of these tiny units of energy through space that constitutes the substance of a radio ray. The exact nature of these little grains is not yet positively known, but it has been definitely established by a series of delicate experiments, performed most accurately by that master of experimental physics, Professor R. A. Millikan, that the actual size of these minute specks of energy is not always the same.

A quantum shot off from an electron whose orbit lies close to the atomic nucleus is larger than a quantum that is radiated from an electron rotating in a larger orbit, further

(Continued on Page 59)

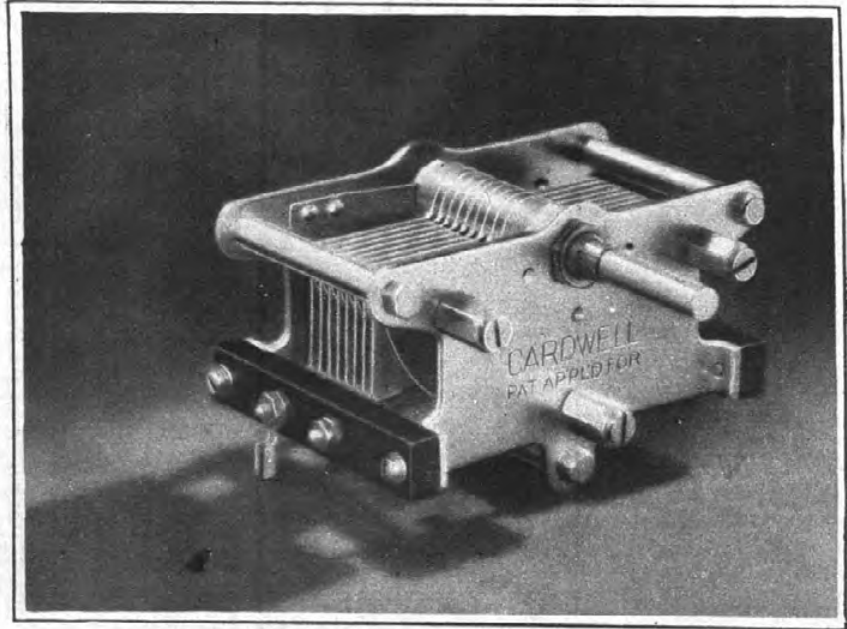

## Insist on CARDWELLS

### The first "low-loss" condensers

CARDWELL invented the original *low-loss* condenser, using metal end plates and a grounded rotor. The phrase "low-loss" was in fact first applied to Cardwell Condensers by engineers to distinguish these highly efficient condensers from the ordinary varieties.

Cardwell Condensers have been universally adopted by radio editors, experts, and professionals. Cardwells have become the standard of comparison.

Performance is the only real test of a condenser. And Cardwell Condensers have proved their superiority because of their scientifically correct design—small area of contact between insulation and stator supports, rigid three-point frame, permanent alignment, accurate adjustment, etc.

Such details permit exceptional distance records, smooth tuning free from noise, and prevent changes in capacity at given settings.

Use Cardwell Condensers in all receivers. There's a Cardwell Condenser for every requirement—seventy-six different types. A postcard brings you an education on condensers.

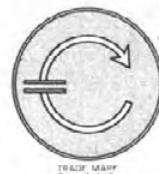

Allen D. Cardwell  
Manufacturing Corporation  
81 Prospect St., Brooklyn, N. Y.

*A Bigger and Better Book at Half the Price*

## If GRIMES of Inverse-Duplex Fame

offered you his services for the price of a movie ticket—you would be interested, wouldn't you?

### But We Can Offer You a Better Bargain Than That

Would it be worth the price of a good dinner to you—to get the combined services and advice of such radio experts as—GRIMES—HARKNESS—NEELY—FLEWELLING—FOOTE—GOOD-REAU—etc.?

The services of the above-mentioned experts cost us hundreds of dollars, but you can get the same services for the trifling sum of \$1.00 (8½ cents per month), by subscribing to *Radio in the Home* for a year. (Twelve monthly issues.)

SEND IN THE BLANK TODAY

RADIO IN THE HOME,

608 Chestnut Street, Philadelphia, Pa.

Please find enclosed check, M. O., cash, for one dollar (one-fifty Canada), (two foreign), for one year's subscription to *Radio in the Home*.

Name .....

Address .....

City ..... State .....

## For Circuit Supremacy— CIR-KIT and Supereflex



Erla Supereflex—new epoch in circuits. Not just a "wave" of popularity, but the permanence of *basically superior* principles, just as advanced today as when Erla introduced the circuits still rated more powerful, tube for tube.

Expressing the best of Erla science, Supereflex circuits also are so easy to own! Not only because of extreme economy in first cost and operation, but also because Erla CIR-KIT enables any experimenter to produce these greater circuits flawlessly. CIR-KIT provides every-needed item of Erla Precision Radio Apparatus—exclusively responsible for matchless Erla range, volume, clarity, sensitiveness and remarkable ease of control.

CIR-KIT also provides full-size blueprints; stenciled base-board; and drilled, lettered panel, so that every step must be correct. Assuring lasting supremacy in circuits; the pride of a truly professional hook-up; and incomparable entertainment, CIR-KIT is outstanding in radio today.

Electrical Research Laboratories  
Dept. Q, 2500 Cottage Grove Ave., CHICAGO

# ERLA



Erla complete radio instruments lift radio to the realm of art, with the same superiorities CIR-KIT brings.

Erla Floor Console

Erla Table Cabinet

Erla Table Console

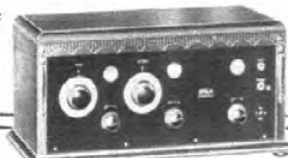

## When Your Set Just Dies

*It may have worked beautifully last week. Then it began to get weaker and weaker and tonight it's dead.*

You've tested everything. Batteries are up, connections O. K., nothing shorted or open, aerial and ground all right. Yet the set's dead. The tubes light, so they must be all right. Ah! but wait. Are you sure? The fact that they light proves that the *filaments* are all right, but what about the grids and plates?

### Can you test your tubes?

It's easy and cheap—when you know how. Then you can spot that *one bad tube* that is killing your whole set.

Read: "How to Tell Good Tubes From Bad Ones"—May issue, Page 6.

"A Tube-Tester Any One Can Build"—June issue, Page 6.

"Tube-Testing Outfit As Used in RADIO IN THE HOME Laboratory"—July issue, Page 31.

**Be sure your tubes are right  
before you blame your set**

Send 30 cents for these three back issues and learn how to test your own tubes.

Circulation  
Department

**RADIO IN THE HOME**

608 Chestnut St.  
Philadelphia

## BEFORE THE "MIKE"

By FRED J. TURNER

A Familiar Broadcaster From Station WEAJ in New York

THE emotions that one broadcasting for the first time experiences, are many. They run from fear to hope and depression to pleasure.

They start with the birth of your idea and end—well—sometimes they never end.

Your interview with the manager of programs is the start of a lot of sensations that you never thought, at the time, were going to be yours. Certain that you have hit upon something new, novel and interesting, you present your plan with an air of supreme confidence. Every trick in selling that you can command is brought into play.

As a B. C. L. you feel sure that you know what's what. You are inwardly positive that the many hours that you have spent twisting dials and listening have fitted you to speak authoritatively on the subject. As you present your idea, you are deliberate in action, careful in diction and studiously polite.

Cool, courteous and considerate, the manager of programs listens. In time you finish and you are diplomatically informed that what you have submitted is quite interesting. Also that if the future programs have not taken all the allotted time, you may be given the opportunity of instructing, entertaining and otherwise amusing that great radio audience that reaches from the rock-ribbed coast of Maine to and beyond the sun-kissed slopes of the Sierras.

Confident that you have put your idea across you leave the radio studio with the emotions of pride and elation somewhat in the ascendancy. At home you gather friend wife and the other immediate members of the family about you and tell them the happenings of the day. Then you proceed to deliver your address, stopping every now and then to disclose why you put such and such an expression in it and such and such an inflection on your words.

Twenty-four hours pass, then forty-eight, then seventy-two—with no word from the radio people. The old emotion of doubt now starts to get in its work.

You ask yourself whether you should call or telephone. You think of some legitimate excuse for getting in touch. But, no, that might not be the right thing to do. Undoubtedly, you think, they are very busy and so you dismiss all thoughts of action from your mind, hoping that the next day will bring with it good news.

With the arrival of the next day, the mail man and no letter from the broadcasting station, your hopes take a decided downward drop and the value which you had placed on your idea goes 'way below par.

But the day does come when you are notified that you have been assigned a day and hour.

Are you tickled silly? I'll say you are. Your chest expands to its fullest; you square your shoulders, lift your head high, while into your eyes comes a sparkle that only a proud man can possess. Even your voice sounds different.

As you meet your friends and acquaintances, you casually—you know, matter of fact sort of way—tell them you are going to broadcast. Of course they literally have to drag all the story from you. Modesty is your first, middle and last name.

And then follow days and nights of martyrdom for your wife and children. Time and again you try

your address on them. You invite criticism and get very indignant when it is offered.

The arrival of the eventful day finds you, as well as those near and dear to you, verging on the edge of nervous collapse.

Perhaps you aren't so good as you thought you were. Maybe you haven't got a radio voice. You don't know whether to hope an S. O. S. signal will be sent out and thus give you an excuse or an alibi, or to hope that nothing will happen to mar the occasion.

You begin to think that it might have been better to have waited and then, if you made good, to have told your friends about it.

For the life of you you cannot get your mind off what is going to happen that evening. The manuscript, which by this time is crumpled and soiled from being handled so much, is brought out and you sneak off into a corner to refresh your mind. It's no use. You read a little and then find that you are thinking of the studio, the unseen audience, and of this and of that until you work yourself up into such a state that you would jump out of the window if any one was to unexpectedly sneeze near you.

You make a bluff at eating supper while friend wife talks to you about everything else other than radio. You think you are fooling the better half of the family by going through the motions of wielding the knife, fork and spoon, but she is wise.

As you put on your hat and coat and kiss the youngsters good-by, you feel terrible.

The ride to the studio is agonizing. Each step in its direction is an effort.

Somehow or other you get some kind of command over your emotions. As you enter the studio and meet the manager, you endeavor to show an unruffled exterior, but, oh Lord, if he could only see inside.

The seat you have selected faces a clock and, try as you will, you cannot keep your eyes off it. The minutes fairly fly as you watch.

The manager is a dandy chap. He tries to set you at ease and to take your mind away from what is before you, by telling you many interesting stories, but as far as you are concerned he is a flat failure. Of course you do not let him know it.

Your feeling are by this time much like the man who is going to his doom. The door leading into the studio has much the same significance as the little green door that opens into the room wherein is the electric chair.

The warden—I mean the announcer—approaches and tells you that you go on next. Those words not only reach your ears, but find their way down into your already horribly upset stomach. Cold chills are now alternating with hot waves as they race up and down your spine.

Into the studio. In front of "Mike." "Good Lord," you think, "how can such an innocent looking object present so terrifying an appearance."

On the wall is a group of lights which you have been told to watch. Green means the announcer is talking, red, that you are to start.

The room is as silent as a tomb. Your old heart is now beating so heavily that you are certain the sound can be heard.

The green light flashes. An all



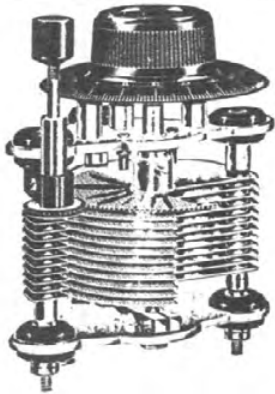

## HEATH RADIANT

### Non-Dielectric CONDENSERS

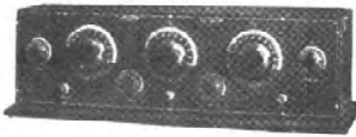

Used in the  
**A-C DAYTON**  
XL5

The A. C. Electrical Co., in designing their Polydyne Receiver, looked for the make of condenser which could stand up under all sorts of usage without lessening its efficiency one particle. That their choice was the HEATH RADIANT Condenser bears out the HEATH claim of permanent efficiency.

The paragraphs below explain the principal reason for this extraordinary durability. You, yourself, can see the other reasons, once you've set eyes on a Heath Radiant Condenser. Everything about it impresses you with its scrupulous workmanship.

You want to make your new set the best yet—then learn about these "better condensers."

Prices for Vernier Condensers		
	With Dial	Without Dial
No. 12AV 12 Plate...	\$5.00	\$4.35
No. 24AV 24 Plate...	5.50	4.85
No. 44AV 44 Plate...	6.50	5.85

Plain types in all sizes

**Permanently Flat Plates**  
Stamped under huge presses to absolute flatness and tempered to prevent warping.

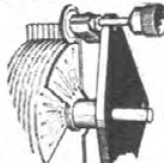

**Micrometer Geared Vernier**  
Ordinary adjustments reduced to hairbreadth distinction. Guaranteed to be more highly selective than any condenser employing a vernier actuating ALL of the plates.

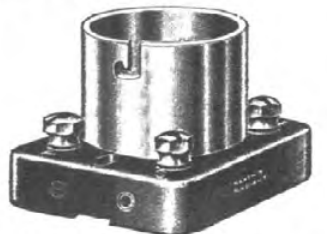

### HEATH Sockets With the Exclusive Shock Absorber Feature

Bakelite base into which re-enforced phosphor bronze, self-cleaning contacts are securely embedded. Binding posts are slotted hexagon nuts. HEATH Standards of material and workmanship. Price 75c

Heath Bakelite dials in  
2, 3 and 4 inch sizes

### HEATH RADIO & ELECTRIC MFG. CO.

205 FIRST ST. NEWARK, N. J.  
Exclusive Canadian Distributors  
Marconi Wireless Telegraph Co.,  
Ltd., of Montreal, Canada

too short wait, and then, up lights the red. The time has arrived.

As you say "hello," your voice doesn't seem to be the one you have been using all your life. Your tricks of expression, which you have striven so hard to protect, seem so artificial.

A picture flashes across your mind. You visualize friend family, as nervous as you, sitting around the old loud speaker. You wonder if any one else is listening.

All the evil deeds you have done as a radio listener come back to haunt you. Are others tuning you out as you have done to others? You register a vow that from this day on you are going to be more charitable in your criticisms.

And then, you lose your place. "Where am I? What was I saying?" You gasp and gurgle, become panic-stricken, and thank heavens, remember where you were, pick up the story and go on.

"Good-night everybody" is a relief. The deed has been done. Off goes the red and on the green light. Out in the reception room you find yourself with beads of perspiration standing out most prominently on your brow.

What a painful period the days that follow are. Half-heartedly you scan the columns of the newspapers and finding that the radio reviewers have written nothing about you, hope that it is an indication that you were not so bad.

You want to, and at the same time do not want to, see the postman. When he has no letters, you are hurt. Then you say to yourself that perhaps the old adage that, "no news is good news" is right.

But the Federal employe in gray does, one day, bring a big envelope containing letters received at the studio. The ceremony of inspecting its contents is somewhat delayed.

And then, when you open the first and see that some one has listened and liked—oh, boy! what a grand and glorious feeling.

### Grimes' Final 3XP

(Continued From Page 8)

in this circuit exactly where it is and then it will not be necessary to change either coil or condenser. The only object of removing it and replacing it in the grid lead is to do away with a rather annoying 60-cycle hum when the hand is on the center dial. To me, however, this hum is not objectionable because, as soon as the hand is removed, the hum stops. The other changes can be made in either of these circuits as well as in the original 3XP.

There are two very great improvements given in Mr. Grimes' article in this number. The first of these is the use of the detector tube with no B battery. The majority of complaints from readers who have tried these three circuits have had to do with howling. In many cases this was due to the fact that the detector B battery voltage was taken off of a tap of the common B battery. In the inverse duplex system, with the three stages of audio-frequency amplification, this led to a feedback which caused a great deal of this howling. In the new system, the detector functions without any B battery, merely using about three volts difference which is set up by the resistance of the rheostat. That is all that is necessary for the mere rectification which takes place in this tube. It avoids the howling.

The second and perhaps an even greater improvement is the introduction of the double pole, double throw switch jack, which enables the user to take audio-frequency amplification entirely out of the first tube and permit it to function as straight radio-frequency amplifier.

On local stations, the Grimes sys-

## The Best "Low-Loss" Condenser at a New Low Price

Being designed by Flewelling himself, there was not much that we could add to this true low-loss condenser to improve it. It seemed that Mr. Flewelling combined all the good qualities of a condenser and discarded all the bad points when he built the original model.

But there was one thing we could change—the price! And we have. Through constantly increasing our production and distribution, we are now able to offer you a real reduction in the cost of the highest grade of low-loss condensers.

**BUELL MANUFACTURING CO.**  
2975 Cottage Grove Ave., Chicago

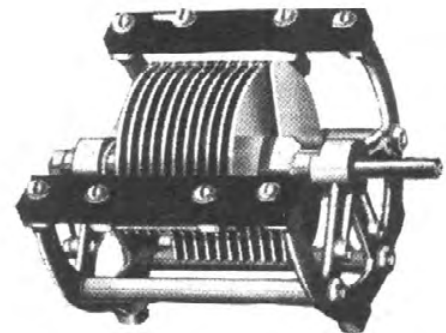

**BUELL**  
RADIO APPARATUS

### New Prices

.0005 mfd.  
Condenser \$5.00

.00025 mfd.  
Condenser \$4.50  
(Vernier included  
50c extra)

### You will be satisfied with a "Pacentized" set

THE man who uses Pacent Radio Essentials in building his set has the assurance that he is using the finest parts that engineering skill and trained hands can build.

That this confidence is not misplaced is shown by the fact that over 40 of the leading radio set manufacturers use one or more Pacent Radio Essentials for standard equipment. This shows the leadership that Pacent has attained in the radio parts industry.

Select the parts for the new set you contemplate building from the list given opposite. Get them from your favorite dealer—he carries them or can get them for you.

**PACENT ELECTRIC COMPANY, Inc.**  
91 Seventh Avenue, New York City  
Washington Minneapolis Boston San Francisco  
Chicago Birmingham Philadelphia St. Louis  
Buffalo Jacksonville Detroit

**Pacent**  
RADIO ESSENTIALS

- PACENT**  
Radio Essentials  
Adapters  
Improved Audioformer  
Autoplug  
Coil Plug  
Coil Plug Receptacle  
Condensers, Low Loss  
Detector Stand  
Duojack  
Duoplug  
Duo-Lateral Coils  
Headsets, Everytone  
Jacks  
Jack Set  
Radioloop  
Loop Plug  
Loop Jack  
Multijack  
Plugs  
Potentiometers  
Rheostats  
Resistors, Laboratory  
Sockets  
Twinadapter, etc., etc.

**"DON'T IMPROVISE — PACENTIZE"**

### ARE YOU COUNTERFLEXING?

Have you built this 3-tube marvel set offered by

### KENNETH HARKNESS

as his latest contribution to replace his famous Reflex?

All developments of the circuit  
will be found exclusively in

**RADIO IN THE HOME**

# Takes the MYSTERY out of RADIO!

Just one book answers every question about this modern miracle



100,000 SOLD  
514 PAGES  
Leatheroid Edition  
Compiled by HARRY F. DART, E.E.  
Formerly with the Western Electric Co., and U. S. Army Instructor of Radio.

Technically Edited by F. H. Doane

BE A RADIO expert—it's easy for the 100,000 who own this compact, complete Radio Handbook. Written in good, plain, understandable language. Crammed full of facts, every one useful and important. Explains how receivers and transmitters work, how to build and operate them. Whatever you or your friends want to know, it's here. Will save you many times its small cost.

**TELLS ALL ABOUT:** Electrical terms and circuits, antennas, batteries, generators and motors, electron (vacuum) tubes, every receiving hook-up, radio and audio frequency amplification, broadcast and commercial transmitters and receivers, super-regeneration, codes, license rules. Many other features.

Nothing else like it. Make this extraordinary book your radio library—just this one little giant is all you need. Everything in one index, under one cover, in one book, for \$1.50. Combines the knowledge of many expensive works. Buy this and save the difference. Stop experimenting in the dark. Before you spend another cent on parts or even touch a dial, sign and mail the coupon below and get this unique guide to successful radio. More than 100,000 sold.

Send \$1.50 today and get this 514-page I. C. S. Radio Handbook—the biggest value in radio today. Money back if not satisfied.

—TEAR OUT HERE—  
INTERNATIONAL CORRESPONDENCE SCHOOLS  
Box 8257-D, Scranton, Penna.

I am enclosing \$1.50. Please send me—post-paid—the 514-page I. C. S. Radio Handbook, bound in Leatheroid. It is understood that if I am not entirely satisfied I may return this book within five days and you will refund my money.

Name.....  
Address.....  
Check here  and enclose \$1 if you wish the cloth-bound edition.

## FLEWELLING'S NEW CIRCUIT

Is creating a furore among dyed-in-the-wool experimenters. If you like to solve the mysteries of radio, this circuit will be the most baffling but fascinating one that you have seen.

You ought to try it!

Get the complete series of articles. They began in the December issue. Ten cents a copy.

**RADIO IN THE HOME**  
608 Chestnut St., Phila.

tem produces such a tremendous volume that the tubes will overload and even if they do not, there are few loud speakers which can carry such volume without bad distortion. And so, when signals are coming in too strong, the mere turning of the knob of this switch-jack cuts out one stage of audio-frequency amplification and does it in the very best position. It is much superior to merely having an extra jack and plugging in on the previous stage of audio frequency.

This present hook-up gives almost perfect control of volume and quality. The tapped primary of the first radio-frequency transformer is intended fundamentally to increase selectivity, but it also controls volume and quality. So, too, does the filament rheostat. In addition, when the volume is still too great, we have this double-pole throw jack-switch which entirely cuts out one stage of audio-frequency amplification. We can then come up on the rheostat or the tap switch and so get any combination of volume and quality which we want.

Mr. Grimes is now at work inverse duplexing the super-heterodyne. He hopes to have it done in time for next month's issue, but personally I doubt this. I think if we get it month after next we will be doing very well. There is one thing we can promise and that is that you are going to have it quite soon. And when you get it, it will be a superhet that will not radiate, even on an outdoor antenna. H. M. N.

### For the Inverse-Duplex Experimenter

(Continued From Page 43)

all the regeneration you want this way, and then a little more, but it is almost impossible to control. I have assumed in the early part of this article that the coils, whatever kind you used, were so mounted as to have minimum or zero magnetic coupling.

While we are on the subject of regeneration, I might remark that I have never been able to get satisfactory results in my many attempts to get regeneration in the detector tube in an inverse duplex. I might also say that I have dabbled with Mr. Harkness' "Counterdon" scheme, but so far have failed to adapt it to this circuit with any success.

I have not touched on antenna operation, shielding or the addition of an extra stage of tuned RF to this circuit. There is a great deal that is interesting to an experimenter in all these fields. Perhaps Mr. Neely will let me write about these things later on.

### That "I-D-P" Sure Perks

(Continued From Page 6)

Funny thing—Seattle comes in well in the daytime, but simply rotten at night.

So, to get back, I hooked my aerial and ground both on the loop—simply scraped some insulation off, and twisted the wires on. And instead of tapping in on the loop for the grid

lead to the first tube, I simply bridged across to that lead from one end of the loop. Oh, one other thing, I was so economical—or lazy?—that I cut some Fahnestock clips off an old "B" battery and used them for binding posts. I have a darned good notion to take a couple of photos of the set as it stands and send them to Prof. Briggs, but that would be rather a mean thing to do, for did he not talk in your December issue of *Radio in the Home* of "the kind of careful, patient experimenting necessary to get the best out of a super-sensitive radio circuit"? And furthermore—but that was the neutrodyne! and we are getting along on the Pfanstiehl without those neutroformers he finds so necessary.

Well, I plugged in some head phones and tested the set to see everything was O. K., and then I proceeded to shoot for stations. This was Sunday evening, and, bingo—in came KGO with their church service. My wife gasped. "Why," she said, "I have never heard KGO quite as good as that before!" "Certainly not," said I, "you never before heard radio coming from an Inverse-Duplex Pfanstiehl set, so how could you?" I myself was genuinely surprised, not alone at the volume, but the tone quality. You surely have originated a set with wonderful tone quality.

Well, I shot every Pacific Coast station, and then got WBAP. KFI, Los Angeles, is only eight meters below WBAP, but they were separated absolutely and completely; and with plenty of room for two or three more stations in between.

And then I went scouting for other W's and picked up WHB at Kansas City. Sweeney's station came in so clear and loud and with such wonderful quality that we stayed with him till we got too sleepy to listen to anything else.

Now I'll tell the world that a hook-up that will produce such wonderful results when thrown together the way I did this is certainly some hook-up. Practically all the stations I got were from 1000 to over 2000 miles away from here, and all rolled in with such volume that I had to turn down the rheostats because the Magnavox was rattling. Even KFRC at San Francisco, with 50 watts, gave the loud speaker all it could handle.

So, like Prof. Briggs, I am now going to do a little of that "careful, patient experimenting" with the I. D. P. You have given us all a circuit that is worth every ounce of careful work a man will put into it. If my set works as it does when put together the way it is, what is it going to do when I put it together the way it should be built?

Time will tell, so I'll write you again from time to time and tell you exactly what results I am getting. And, believe me, your hook-up is going to get all the time and attention I can possibly give it.

The Inverse-Duplex Pfanstiehl circuit is one of the most distinctively worthwhile hook-ups that I have ever run across. Why bother with superhets? I for one will never again.

Yours very truly,  
IVOR BASSETT.

The Radio Shop, Aberdeen, Wash.



## on the dot

It's as easy as placing your pencil point on a town on the map—this tuning in with Apex Vernier Dials.

They make logging a simple matter and "getting a station" positive. The ratio is 12 to 1. Sell in Royal Brass Finish for \$2.00—Satin Silver Finish \$2.50—DeLuxe Gold Plated (24k) \$3.50. Applied to any shaft—quickly.

Apex 7-Tube Microdyne—Super-Heterodyne knock-down sets sell for \$97.50. The Apex Super Five in a Walnut Cabinet is \$95.00. See your better Radio Dealers.

Apex Electric Mfg. Co.  
1414 W. 59th St.  
CHICAGO  
DEPT. 112

# ATLAS

## RADIO TUBE

"BRINGS IN THE WORLD"

### INSTRUMENT TESTED

Type A, 5 volt, .25 ampere

Read the guarantee furnished with every Atlas Tube:

"This Atlas Tube has been individually instrument tested and is guaranteed to give entire satisfaction. If unsatisfactory for any reason whatever, it may be returned within a period of thirty days to the manufacturer or to the dealer from whom it was bought, provided the filament has not been burned out.

"Dealers are authorized by the manufacturer to make replacement or refund (in such cases) whichever may be desired by the customer.

**Atlas Instrument-Tested Tubes** are guaranteed to function efficiently in Reflex, Neutrodyne, Superheterodyne, Radio Frequency or any of the circuits which require highest efficiency in tubes."

At best dealers or direct from us. Mail orders promptly filled. **\$3.00**

**SPECIAL OFFER**—At no extra charge, we will furnish selected, instrument-tested, matched tubes in sets as follows:

Reflex Set—3 Tubes ..... \$9.00  
Neutrodyne Set—3 Tubes ..... 15.00  
Superheterodyne Set—8 Tubes, 24.00

They will get the most out of your Radio Set.

DEALERS and JOBBERS—There is satisfaction as well as profit in handling ATLAS TUBES, the first tubes to be sold on merchandising principles affording full protection and satisfaction to your customers.

Write or wire for proposition.

## THE IRSK CO

310 Caxton Building, Cleveland, Ohio  
771 Ellicott Square, Buffalo, N. Y.  
609 Chamber of Com., Pittsburgh, Pa.

**I will buy for you!**  
Free Shopping Service for Readers of this Magazine

I will buy any apparatus mentioned in this magazine and send it, carefully packed, direct to your door, at its regular price, plus only parcel postage and insurance.

**I MAKE NO CHARGE FOR THIS SERVICE**

It is conducted in co-operation with Mr. H. M. Neely, and is for the convenience of his readers.

**LONG DISTANCE, PLEASE!**  
**Schicklering Tubes**  
*More Distance, Less Noise*  
The 4th element grounds eddy currents—that's the secret.  
S-200— $\frac{1}{4}$  amp.  
S-900—1-10 amp.  
**Price \$4.00**  
We have them in stock. Try a set and note the difference.



DO NOT MISS the pleasure of building the latest **Grimes 3XP Circuits**. Reports indicate they are the greatest developments in radio this year.

Complete Kits of Parts, including Panel, Baseboard, Celatsite Wire, and either the Fada Neutroformers or the new Pfanstichl Tunc-ra-former **\$55.00** Unit

Kit adheres strictly to specifications and will build sets exactly as pictured in September and November issues.

**E. M. CLARKE CO.**  
1523 Chestnut St.  
Room 301 Phila., Pa.

**The Amazing Story of the Radio Ray**

(Continued From Page 55)

away from the nucleus. It is also known that the frequency of emission, that is, the number of volleys or clouds of quanta shot off per second from electrons rotating in the inner orbits, is greater than the frequency of emission coming from electrons rotating in the outer or larger orbits.

Frequency, as we know it in radio, is simply the number of volleys of these grains of energy that are shot off in one second. It follows that the so-called "wave length" is simply the number of meters that one volley or cloud of quanta has traveled before the next one is started on its way. They actually travel, you remember, at the speed of 186,000 miles, or 300 million meters per second.

For example, if one million volleys are shot off every second the frequency will be one million, and each volley will have traveled 300 meters before the next one is started. Therefore the wave length is said to be 300 meters. The greater carrying power of the shorter radio waves of 100 meters or less was first demonstrated a few years ago by amateur experimenters against what was predicted on the basis of the older ether wave theory. This may find an explanation in the fact I have just stated that the higher the frequency, the larger will be the size of the individual particles or quanta radiated.

X-rays, light, radiant heat and similar phenomena are all explained on exactly the same basis. They differ from radio rays only in frequency. Our eyes are in reality radio receivers tuned to respond to a narrow band of very high frequencies. When the frequency of radiation is 400 million million cycles per second we perceive the color red. When it is increased to 750 million million cycles our eyes interpret the rays as violet light. All other colors are caused by various combinations of frequencies lying within these two limits, outside of which our eyes cannot respond.

The heat perception centers of our skins are also radio receivers which are tuned to frequencies somewhat lower than those to which our eyes respond, and the physiological sensation in this case is heat instead of color.

There are many different methods by which atoms can be made to radiate at various frequencies, but we must confine ourselves now only to the one used for producing radio rays. In order to produce the frequencies used for radio transmission, which are very much lower than those necessary for light and heat, we must establish what might be called an artificial electron orbit, having a circumference infinitely larger than the largest natural orbit of the electrons found within an atom.

A coil of one or more turns of copper wire or the equivalent, constitutes, in effect, such an artificial orbit. If a stream of electrons, or in other words an electric current, is made to oscillate or jerk back and forth in this coil, radiation of quanta into space takes place.

The frequencies found useful for radio transmission are far below that which our eyes or skin can directly receive, therefore we are compelled to construct artificial receiving instruments. When radio rays strike a receiving antenna or loop which is properly tuned, they cause a minute electric current to flow back and forth in the wire, usually at the

**MAGNATRONS**



MAGNATRONS today are better tubes than they ever were before and that is saying a great deal. MAGNATRONS occupy a front rank position among vacuum tubes; they know no superiors and very, very few equals.

MAGNATRONS have been changed both internally and externally. All types are now manufactured in the tipless form. This is an important feature; it greatly reduces the chance of accidental breakage. The bases, too, have been improved. Pure bakelite is used, thereby cutting down leakage and capacity.

The internal changes in MAGNATRONS make these tubes more fitted than ever for efficient radio frequency amplification and powerful audio frequency amplification without distortion. Convince yourself on this point by hooking a MAGNATRON into the circuit.

MAGNATRONS are made in three types — the DC-201A, the DC-199 with the miniature base, and the DC-199 with the large standard base. The list price of all types is \$4. Your dealer will be glad to show MAGNATRONS to you.

**CONNWEY ELECTRIC LABORATORIES**  
309 Fifth Avenue NEW YORK CITY

**CARTER**  
**New Potentiometer**

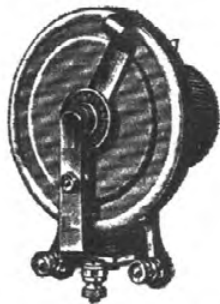

200 and 400 Ohms **\$2**

Made by special CARTER designed machinery which guarantees a perfectly evenly spaced coil—No jerks or jumps in the resistance—but a smooth, steady increase or decrease as desired.

Any dealer can supply

In Canada  
**CARTER RADIO CO., Limited**  
Toronto, Canada

**Carter Radio Co.**  
1813 REPUBLIC BUILDING  
CHICAGO

**RADIO PRODUCTS of DISTINCTION**

**The DAVEN Resistance Coupled Amplifier Kits**



THE DAVEN SUPER-AMPLIFIER UNIT

A laboratory-tested Resistance Coupled Amplifier. This unit comes ready to install—the base is of molded Bakelite and small enough to fit within any cabinet. All connections hidden beneath the base.

Sold Everywhere.

Ask your dealer for our 25c booklet, "The RESISTOR MANUAL," which tells all about the many possibilities of Resistance Coupled Amplification and how to use it.

ADD THE DAVEN RESISTANCE COUPLED AMPLIFIER to your favorite tuner and you will have a worthy combination, hard to beat and amplification that is perfect.

The assembly of a DAVEN AMPLIFIER is very simple, while the satisfaction of having built such a perfect device yourself is beyond mere words to describe. Its volume is adequate for all purposes—its perfect tone quality and lack of distortion place it beyond comparison.

These Kits can be purchased at all good Radio Stores—supplied in either three or four stages, sockets and mica fixed condensers not included. Complete instructions and diagrams with each Kit.

**DAVEN RADIO CORPORATION**  
Resistor Specialists  
Newark New Jersey

**"The Aristocrat of Amplifiers"**

## L+K Clarifying Selector

### Greatly Improves Any Standard Hookup

WHETHER your set is an Erla or any other reflex, an Ultradyne, a R. F. or a Regenerator, you can easily give it that high selectivity and perfect control so necessary where stations interfere.

Just replace variocoupler, fixed coupler, tapped coil or aerial variometer with an L+K Clarifying Selector and a .0005 variable condenser.

This improvement clears up muffled signals—gives minute selectivity—permits complete control of antenna coupling over entire B. C. wave band—cuts down antenna losses and strengthens reception, and does away with tapped coils and high-loss aerial tuners. Price \$7.00.



Patent Applied For

#### Send for Free Book

showing complete L+K line, Greene Concert Selector hook-up, and other effective circuits. (Jobbers, Dealers—write)

Dept. R., 654 Grand Ave., New Haven, Conn.

**LANGBEIN+KAUFMAN** **L+K**  
High Grade "Low Loss" Tuning Devices A Guide to TECHNICAL ACCURACY

same frequency at which the quanta were radiated. This minute electric current can be amplified thousands or even millions of times and then converted into sound in the radio receiver.

Naturally the actual amount of energy picked up by a receiving antenna is extremely small. It has been estimated that the amount of energy picked up by an average receiving antenna coming from a broadcasting station 2,000 miles away, if made continuous day and night for thirty years, would about equal the energy expended by a common house fly in climbing up a wall a distance of one inch.

This new conception of a radio ray, while still incomplete in many details, is probably far nearer to the actual facts than the older theory of a simple wave motion in a hypothetical substance called the "ether" or "space," the actual existence of which has never been directly proved, while recent experiments seem strongly to indicate that it does not exist.

In closing, I would like strongly to urge all the young radio experimenters, from whose ranks the next crop of physicists and scientists will come, to pay less attention to the spectacular and "stunt" side of radio and devote more time to the serious study of the basic principles underlying the subject as laid down in the new physics, as it is only through a better understanding of the fundamentals that real progress in this fascinating art is likely to be made.

To be living in a period when nature is yielding her final secrets is, indeed, inspiring; and to the coming generation is given the incomparable opportunity of finding a solution, perhaps, to the riddle of life itself.

The diagrams printed with this article give further amazing pictures of the actions of atoms and electrons and are intended to supplement Mr. Pfanstiehl's remarks. They are:

Figure one represents an atom of Hydrogen, the simplest of all the atoms. It consists of a nucleus or "sun" composed of one proton around which revolves a single electron or "planet." The circle indicates one of the several orbits the planetary electron may take. The dot in the center indicating the nucleus is much too large. If it had been drawn relative to the size of the electron orbit, you would require a microscope to see it!

Figure two. This represents the second atom in the series, namely, Helium. Its nucleus is composed of four protons and two electrons. There are two planetary electrons spinning around, as indicated by the circles. The nucleus (as in figure one) is drawn several thousand times too large!

Figure three. Here we have an atom of Argon, with its 18 planetary electrons. This is one of the so-called "inert" elements because it will not enter into chemical combination with any of the other elements. The symmetrical or "satisfied" arrangement of the orbits of its planetary electrons explains its unwillingness to combine with other atoms.

Figure four. Now you know what an atom of copper looks like—that is, if you could see the paths or orbits its planetary electrons take as they play "merry-go-round" around the nucleus. There are 29 planetary electrons distributed in four concentric spheres or shells—yet not a millionth part of an atom of copper is actual substance! If a planetary electron is made to suddenly jump from one orbit to a smaller one, a single quantum of energy is shot off

When  
the phone  
rings

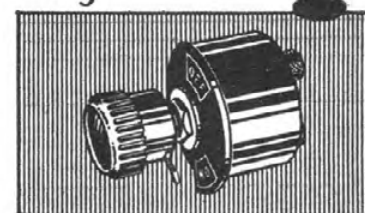

**Snap ~**  
**AND ALL IS SILENT**  
**Snap again ~**  
**AND THE PROGRAM**  
**CONTINUES ~**  
*without retuning*

No modern set lacks the convenience of a MAR-CO filament battery throw switch. Its definite on and off positions make it far superior to any pull switch. Saves tubes and batteries—you don't forget to turn them off! Saves annoying interruptions when you only want to stop reception for a minute!

Make your set  
convenient with a  
**MAR-CO**

ON AND OFF  
BATTERY  
SWITCH **\$1.00**

## INVERSE DUPLEXING THE SUPER-HET

David Grimes is working on it now. It will retain all of the super's many advantages and will do away with the disadvantages.

### EXCLUSIVE FEATURES

Six tubes do the work of 8.

Absolutely nonradiating.

Improved tone quality.

Reduced first cost.

Lower upkeep expense.

We'll publish it soon.

Watch for it in

**RADIO IN  
THE HOME**

## "The Low Loss Supercoil" Trade Mark

THE LOW LOSS  
THREE CIRCUIT  
TUNER  
FULLY ADJUSTABLE COILS

The Heart of the Set

Tremendous  
Volume!

Great Distance!

Razor-Sharp  
Selectivity!

Unequaled Clarity!

### Points of Superiority

- 1 It is the only fully adjustable coil on the market. You can "set" it to meet the precise needs of your antenna, ground, tube, plate voltage and wiring.
- 2 It is self-supporting—has no dope or varnish—no metal parts, to reduce signal strength.
- 3 It has less than 1/2 oz. pure hard rubber and bakelite—a minimum of energy absorption.
- 4 Number 18 wire used—large, but not too large—to insure low resistance.

Send three 2c stamps for Easy-to-Read Hook-Ups and bulletin on Low-Loss Design, the Beginners' Best Bet.

Jobbers and  
Dealers  
Write for  
Territories  
Open

THIS COIL IS ADJUSTABLE TO SUIT YOUR TUBE, PLATE VOLTAGE, AND WIRING, PRECISELY. THIS PREVENTS SQUEALING & RERADIATION

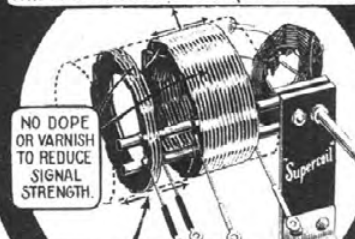

THIS COIL IS EXACTLY ADJUSTABLE TO SUIT YOUR ANTENNA AND GROUND. NOT A COMPROMISE.

REDUCES STATIC TO A MINIMUM BECAUSE OF ITS SHARP SELECTIVITY.

\$7.00

The Coil indorsed by H. M. Neely—the non-radiating coil  
If your dealer cannot supply you, send us his name and \$7.00 plus parcel postage

**PERFECTION RADIO MFG. CO.**  
DEPT. R—24TH & RACE STS., PHILADELPHIA, U. S. A.

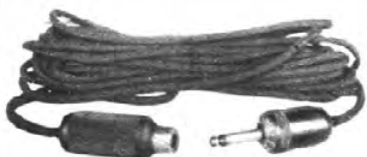

(Patent Applied For)

A NEW Four-Way Product!

## Loud Speaker Extension Unit

COMPLETE

THIS COMPLETE UNIT enables those who want to use the loud speaker in other parts of the house to do so without removing set. Insert plug from loud speaker into jack; place plug on end of cord into set. This can be done readily and saves the trouble of using tools or soldering iron.

Prices, including Jack, Plug and Cord:

10-foot cord \$2.25    40-ft. cord \$3.00  
20-foot cord 2.50    50-ft. cord 3.50  
30-foot cord 2.75    100-ft. cord 5.75

At Your Dealer's

Manufactured by

Four Way Co. :: Myrick Bldg. ::  
Springfield, Mass.

## RADIO DEALER CATALOG FREE

Largest Eastern Distributors for National Products

NaAid Products	David Grimes, Inc.
Radiion Products	Kenneth Harkness
Bremer-Tully	Amperite
Cardwell	All-American
Daven Products	Transformers
Erla	Modern
General Radio	Transformers

TRILLING AND MONTAGUE  
49 N. 7TH ST., PHILA.

## KEYSTONE RADIO LIGHTNING ARRESTERS

Perhaps you're not getting the best reception because you aren't using a Low-Loss Keystone Arrestor. The Low-Loss Keystone, made from genuine Bakelite with solid brass parts, provides perfect insulation between aerial and ground. To comply with fire laws you must use a Lightning Arrestor. It will pay you to install a Low-Loss Keystone Arrestor. Approved by Fire Underwriters, E1885. Get one today.



\$1.50 Complete    \$2.00 In Canada

ELECTRIC SERVICE SUPPLIES CO.  
Philadelphia    New York    Chicago

## HERCULES Aerial Mast

All Steel Construction  
Painted black; complete with galvanized steel guy wires and mast-head pulley. 20 ft., \$10; 40 ft., \$25; 60 ft., \$60. We pay the freight. Ideal for receiving or transmitting. Greater range and more satisfactory results. Write for literature and large Free Blueprint

S. W. HULL & CO.  
Dept. W3  
2048 E. 79th St., Cleveland, O.

into space, and the atom is said to have been "stimulated to radiate." If, on the other hand, an atom is made to absorb one quantum of energy, in so doing an electron is forced to jump to a larger orbit.

Figure five. This is the way physicists think of an atom of radium. It is the eighty-eighth atom in the series and therefore has 88 planetary electrons, distributed in seven concentric shells, and all are whirling madly around the nucleus. Into its nucleus—which is not materially larger than the nucleus of a hydrogen atom—is crammed 226 protons and 138 electrons. Protons repel protons and electrons repel electrons, but protons and electrons attract each other—all with tremendous energy. The atoms of radium are so complex and the pent-up forces so great that every once in a while a nucleus spontaneously explodes and shatters the atom, which results in the formation of atoms of the simpler elements.

In about nineteen hundred years one-half of all the radium now on earth will have disintegrated, but more will have been formed by the explosions of uranium atoms, which are the most complex of all. What will happen when all the uranium in the world is used up? No one knows, but don't worry; it will not happen for a few billion years yet! Bertrand Russell sums up the situation as follows: "In this respect, as in some others, the universe seems like a clock running down with no mechanism for winding it up again. All the uranium in the world is breaking down, and we know of no source from which new uranium can come. Under these circumstances it seems strange that there should be any uranium. But if, like some insects, we lived only for a single spring day, we should think it strange that there should be any ice in the world, since we should find it always melting and never being formed. Perhaps the universe has long cycles of winding up and running down; if so, we are in the part of the cycle in which the universe (or at least our portion of it) runs down. Everything pleasant is associated with this running down, because it is only this process that liberates energy for the purposes that we regard as useful." ("The A B C of Atoms," page 113.)

### "Just Write Jean Sargent"

(Continued From Page 53)

ideas as to woman's place in radio and has written about them. Instead of "lifting her stuff" I'll merely say that whether you agree with her or not, you will have to admit that her theories work out well in practice. So that you will not miss the novel combination of a woman who has something to say, and who says it well and convincingly, I am going to let you listen to her talk—"For Men Only." Gentlemen,—Jean Sargent!

"Good Evening Gentlemen—now that we are alone, and I trust that you have seen to it that we are alone—I have a little plan to unfold—a very confidential plan which may be one more proof of the wonderful possibilities of Radio, and may illustrate again how it fairly walks into our lives and smooths out difficulties which we thought had to be there.

"This is about Christmas, and I know that I am not the only woman in the world who realizes how hard a man finds it to play his full part in the holiday festivities.

"I am not the only one, perhaps, who appreciates what a drain on time, pocketbook and imagination it is for a man to keep the reputation of Santa Claus up to the required pitch of generosity and jollity. But perhaps not many women have dared

## The Largest Selling Transformers in the World

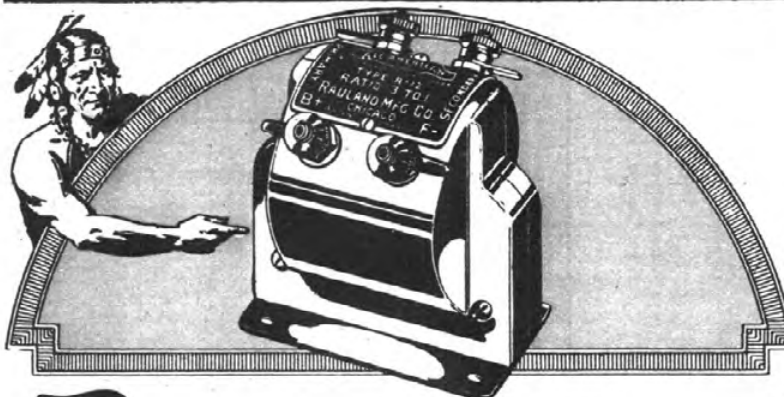

# Reliable!

ALL-AMERICAN Standard Audio Frequency Transformers in any radio receiving set mean but one thing—assured efficiency in amplification. Since 1919, ALL-AMERICAN Audios have answered the demand for an instrument that could be relied upon for maximum amplification and faithful tone reproduction. Set builders who know radio do not experiment—they specify ALL-AMERICANS, with full assurance that they will consistently perform with highest efficiency.

### ALL-AMERICAN REFLEX RECEIVERS

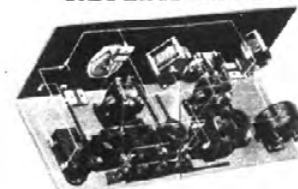

**Precision-Made**  
ALL-AMERICAN reliability is a natural result of highly developed precision manufacture. Each part is scientifically designed and accurately built to exact standards. Special machinery and testing equipment assist in achieving perfection. 3 to 1 Ratio, \$4.50. 5 to 1 Ratio, \$4.75. 10 to 1 Ratio, \$4.75.

**The Radio Key Book** is the most valuable book of radio facts ever published. Sent for 10 cents, coin or stamps.  
RAULAND MANUFACTURING COMPANY  
Pioneers in the Industry  
2666 Coyne St. Chicago

Complete receiving sets with range, volume and selectivity unequalled in receivers of this type. All instruments are mounted on panel and baseboard ready to be wired. Clear photographs and blueprints make wiring the easy task of one delightful evening.  
All-Amex Junior (one-tube) (semi-finished) \$22.00  
All-Amex Senior (three-tube) (semi-finished) 42.00

There's an All-American Transformer for every circuit

# ALL-AMERICAN

## Brings in the D. X. Stations with bell-like clearness

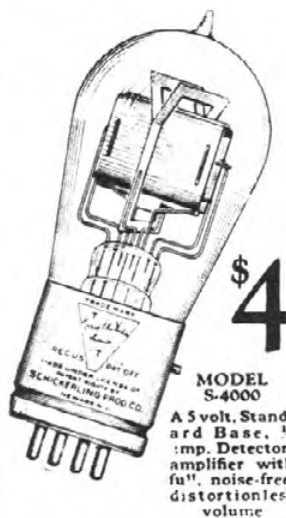

\$4

MODEL S-4000  
A 5 volt, Standard Base, 1/2 amp. Detector-amplifier with "su" noise-free, distortionless volume

Those annoying, sputtering tube noises that mar distant reception are eliminated in Schickerling Tubes and their supersensitivity enables you to reach out and bring in stations you never logged before. The freedom from distortion and tube noises is due to the 4th element, the Triangular Stabilizing plates, the exclusive Schickerling feature.

Get the most out of your set with Schickerling Tubes. On sale and demonstrated at:

### SHICKERLING PRODUCTS CORP.

Factory:

401-407 Mulberry Street, Newark, N. J.

New York Office:

Knickerbocker Building, Broadway & 42nd Street

Philadelphia Office:

Jefferson Building, 1015 Chestnut Street

Pacific Coast Distributors:

The Yale Corporation

Los Angeles and San Francisco, California

also Rudolph Wurlitzer Company's 46 Stores

as well as authorized Schickerling agents.

Mail Orders Filled from our Newark Factory

# SCHICKERLING RADIO TUBES

With the Stabilizing Triangular Plates

- OTHER MODELS**
- 5 volt - 1/10 amp. - Standard Base
  - Model S-100 Detector . . . . \$4.00
  - Model S-900 Amplifier . . . . 4.00
  - Model S-2000 Det.-Ampl. . . . 5.00
  - 5 volt - 1/2 amp. - Standard Base
  - Model S-200 Detector . . . . \$4.00
  - Model S-4000 Det.-Ampl. . . . 4.00
  - Model S-700 Power Tube . . . . 7.00
  - Model S-2500 Det.-Ampl. . . . 5.00
  - 3 volt - 1/10 amp. - Miniature Base
  - Model S-600 Det.-Ampl. . . . \$4.00
  - 3 volt - 1/10 amp. - Standard Base
  - Model S-400 Det.-Ampl. . . . \$4.00
  - 1 1/2 volt - 1/2 amp. - Standard Base
  - Model S-300 Det.-Ampl. . . . \$4.00

**Each a Leader in Its Field!**



**STERLING "FULL RANGE" AUDIO FREQUENCY TRANSFORMERS**

The equal amplification of all audible vibrations has at last been made possible. The beautiful low tones of the cello or organ, the clear high tones of the violin or female voice, in fact the whole gamut of sounds, musical or otherwise, are faithfully reproduced by the Sterling "Full Range" Audio Transformer. You will never know how much of the splendid entertainments you have been losing until you have tried this wonderful new design of transformer. You will for the first time hear the full, round, pleasing tones of the broadcasters as though you were in their studio. Rich in appearance, compact, improved wiring facilities.

**Price, \$6.00**

**Each a Contribution to Radio Comfort!**



**STERLING "SOFT TREAD" RHEOSTAT**

Once you have used a "soft tread," you will agree that its virtues you have not been exaggerated. You cannot feel the broad scientifically formed contact move from wire to wire and there is absolutely no wobbling. You obtain unbelievably free, smooth, noiseless movement in either direction. The customary bronze sensation will not come later, either. The non-tarnishing resistance wire and phosphor bronze contact are completely encased and securely mounted on a completely moulded bakelite base and nickel case. Beautiful thing too, with hole, easily and securely mounted through single hole. (5 and 15 ohm)

Price, \$2.00 (5 and 15 ohm)  
Potentiometer, \$2.75 (400 ohm)

**THE STERLING MANUFACTURING COMPANY**

2831-53 Prospect Ave. Dept. K  
Cleveland, Ohio

Send for interesting booklet of Sterling Radio Equipment, Diagrams, Hook-Ups and Log Record Pages. It's free.

# Sterling

**RADIO EQUIPMENT**



## OSCILLATION LIMITS AMPLIFICATION



**Kompentrol**

The tendency of radio frequency circuits to oscillate definitely limits the amount of amplification possible and therefore definitely limits the sensitivity of the set. Neutralizing and potentiometer control kill the oscillations by putting on the brakes but there again the sensitivity is limited.

sents a new method of utilizing all the sensitivity possessed by tuned radio frequency but controls oscillations without the necessity of "putting on the brakes." It is a *compensating control*.

Therefore  
**KOMPENTROL**  
(Five tubes: 2 tuned radio frequency, detector and 2 audio frequency)

THE KOMPENTROL pre-

## KARDON PRODUCTS CO., Inc.

451 Greenwich St., New York

Philadelphia Office      403 Press Bldg.



step right up with an idea to help you over these rough spots—that is just what I am doing now.

"Men are absolutely necessary to a merry Christmas. They play the leading role—but the women and children keep them going—they set the stage, pull back the curtains and furnish the applause. A woman knows exactly what the man ought to do and is disappointed if he fails to catch the full idea of his part.

"So there you are, figuratively, if not actually, all dressed up in red cap and white whiskers with a sofa pillow under your belt (if necessary) and surrounded by a circle of eager women and children just waiting for you to do something wonderful. And, if you are listening to me, you will be fully prepared for that exciting moment. You will not only get by, you will be a riotous success. I will have prepared everything before hand.

"To aid men in general and particularly that Christmas shopper who postpones his sally into the—shall I say—arenas of Christmas combat until so late that things are picked over—WNAC under my direction is opening a special department—a Christmas feature.

"If you will check up your list of family and friends, adding perhaps a footnote here and there, such as, 'Grandma, aged 73, but looks 45 and sporty—Five Dollars'—and send it to me, we are prepared to do the rest. All we need is such a list. We are bursting with ideas of our own, and when you come for the answer to your problems, or the gifts themselves, they will not only be appropriate, but in the latter case, wrapped to the queen's taste in tissue paper and ribbons and fixings, with or without outside paper for mailing, as required. You may then preen yourself and have that grand and glorious feeling that comes when a great load has been lifted from your chest.

"Christmas morning will find you a knock-out, an ace, a regular right bower of old Santa himself. No doubt your head will be turned by all the nice things that you hear. You will believe them, of course—why not? After all, this is the age of efficiency. Such difficulties should be turned over to an expert instead of fussing with them yourself.

"If you feel uncertain, try my plan on a few of the hard ones and see the results. If you are an over-worked executive with a large number of expectant employees to remember with gifts—something nice, not too intimate, nor too expensive—I am especially interested, for there is, indeed, need of thought and ingenuity. One must know where and how to find the proper thing.

"Simply make the notation of who and how much, with whatever details you can give as to his or her characteristics—suggestions will be submitted which you can accept or reject as you like. When you make a final decision your part will be all over but receiving the enthusiastic exclamations of wonder and delight on Christmas morning.

"There are twenty-eight days left until Christmas—four of these days are Sundays and one is a holiday. It will take a day and a half to get your list to me. You will need time to make it up. I will need time to search out the proper things. In other words, please start right now, to lay the foundation of your merriest Christmas.

"There is no charge for this service. Just address your S. O. S. to Jean Sargent, care WNAC, Boston—or bring it in and tell me about it. This is all in strictest confidence, of course—just between you and me. I'm ready—let's go—good night."

### THE AMPLIFEX LOOP

Litzendraht wound.  
Tapped for 3, 4, 6, 9, 10 and 13 turns, with NO DEAD END LOSSES. Wave length range 88 to 1000 meters.  
Collapses by turning one thumb nut.  
Compass is base for directional adjustment.  
43 inches high, 39 inches wide.

*Guaranteed to be the most efficient Loop made*

Mr Henry M. Neely says: "Very fine workmanship . . . extremely clever . . . its efficiency has surprised me."

*Manufactured by*

**Amplifex Radio Corporation**  
Arlington, Mass.      Dept. U



### BRACH AERIAL ANTENNA

**brings the world to your home**

A fitting companion to every good radio set is the Brach Complete Aerial Outfit.  
All essential parts, including the famous Brach Vacuum Arrester in one package. Each part of highest grade, selected by experienced radio engineers.  
*Full instructions for easy installation with each outfit.*  
Featured by Leading Radio Dealers.

**L.S. BRACH MFG. CO., NEWARK, N.J.**

Wire Your Set With  
**"CELATSITE"**

You can't beat it for a neat job. It's No. 14 tinned copper wire with varnished insulation. Highly dielectric; moisture proof. Bends without cracking. Strips like the bark on a whistle! Looks like spaghetti, but is smaller. Five beautiful colors. Send for FREE FOLDER. "How to Solder", also describes "Celastite" and other Acme products.

**THE ACME WIRE CO.**  
Dept. R, New Haven, Conn.

**ACME WIRE**  
RADIO NEEDS

Use RESISTANCE!



**DURHAM GRID LEAKS**      **75¢**

Variable:  
No. 101. 1 to 5 megs. for soft tubes  
No. 201A. 2 to 10 megs. for hard tubes  
No. 100. 1000 to 100,000 ohms by pass  
Metalized Fixed:  
Over 1/4 meg., 50¢; under, 75¢  
At dealers or postpaid  
**DURHAM & CO., Inc., 1838 Market St., Phila.**

### E B Y

**BINDING POSTS**

Twenty-five  
Different  
Engraved Tops



They Don't  
Lose  
Their Heads



ANT



LOOP

At dealers' everywhere  
**H. H. EBY MFG. CO.**  
Philadelphia



## Inside Information on Type 3XP INVERSE DUPLEX

*That Gets 6-Tube Results With 3 Tubes*

Readers of RADIO IN THE HOME have shown such a friendly interest in my own official laboratory Model 3XP, that I have decided to devote the paid space of my company to a short summary and explanation of how it accomplishes six-tube results with three tubes.

The instrument is so arranged that two stages of tuned radio-frequency amplification a tuned fixed detector, and three stages of audio amplification are obtained, employing but three tubes. This is done in the manner indicated in the sketch. This explanation is proof positive and is the precedent for others, who are making such extraordinary claims, to substantiate them.

The set employs a fixed detector or rectifier because of its clearness and efficiency. Such a device

uses no currents from either "A" or "B" batteries and is much more uniform in its performance than the well-known variable detector tubes. The fixed detector is relatively inexpensive and this fits in with the Inverse Duplex policy of economy.

It is not generally appreciated that different receiving conditions demand different types of radio receivers. It is with this thought in mind that the 3XP was developed to satisfactorily meet the maximum number of requirements. Incidentally, for economy in first cost, tube

replacements and low cost of maintenance, Type 3XP is unexcelled.

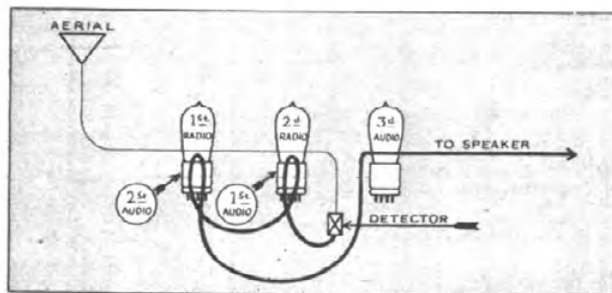

*Chart Showing Circuit of Type 3XP*

*David Grimes*



Inside view of Type 3XP showing position of 3 tubes and fixed detector.

**David Grimes**  
INCORPORATED

**INVERSE DUPLEX SYSTEM**

*Insures Natural Tone Quality*

Type 3XP, with the most economical circuit on first cost and also on maintenance. Retails without accessories at only \$85





List of Leading Articles Which Appeared in  
**RADIO IN THE HOME**  
 FROM FEBRUARY, 1924, TO DECEMBER, 1924, INCLUSIVE — PRICE FOR  
 COMPLETE SET OF ELEVEN ISSUES

**\$1.00**

(The December, 1923, and January, 1924, issues are out of print)  
 Single Copies, 10 cents Each

INDEX TO THE BEST IN RADIO CIRCUITS, RECEIVERS AND APPARATUS

	Page No.		Page No.
<b>FEBRUARY, 1924</b>		<b>AUGUST, 1924</b>	
Circuit Tuning With Condensers.....	9	The Neurodyne—Installation and Operation.....	9
Grimes Designs New Coil for His System.....	14	Audio-Frequency Amplifiers.....	11
Lots of Volume With This Three-Circuit Coil (Kelcoil).....	16	Neuroformers in the Grimes 3XP.....	13
Simplified Reflex for Real Quality.....	24	Correct Aerial Insulation.....	16
How to Figure Your Aerials.....	28	The Greene "Selector".....	18
Two and Three Step Amplifiers.....	30	A Tube That Eliminates the "A" Battery.....	34
The "Levin Singletrol" Circuit.....	31	<b>SEPTEMBER, 1924</b>	
Have You Heard the Short Wave Lengths?.....	38	Grimes-ing the Hazeltine.....	7
Try This Turn of Wire Around Your Coils.....	41	How I Inverse-Duplexed the Neurodyne.....	9
<b>MARCH, 1924</b>		3XP Style Wire-Ups of the Inverse-Duplexed Neurodyne.....	11
Super-Heterodyne (M. & H. Circuit).....	7	Radio-Frequency Amplifiers.....	14
Push-Pull Amplifiers.....	12	Plate Juice From the Lighting Socket.....	22
Listen-in on the Short Waves.....	15	Building Radio Sets That Work.....	24
Multiflex Tuned-Plate Reflex.....	17	<b>OCTOBER, 1924</b>	
The Grimes Circuit for Dry Cell Tubes.....	24	On Resistance Coupled Amplification.....	6
Goodreau Answers Questions About His Famous Circuit.....	28	The New Harkness Counterflex Circuit.....	11
<b>APRIL, 1924</b>		3XP-Style Wire-Ups of the New Harkness Counterflex.....	14
Grimes Designs a Portable Inverse Duplex.....	8	New Sets of this Season.....	24
Three Tubes in a Corona Case.....	10	The Neurodyne.....	25
The Langbein and Kaufman Circuit.....	14	New 110-Volt Tube with Replaceable Filament.....	26
Goodreau's Spiderweb Portable Set.....	17	Tubes—A Survey and a Forecast.....	26
Lightning a Danger? Not a Bit!.....	19	Notes on the Grimes-Briggs Neurodyne.....	34
Don't Shield—Wire Up Correctly.....	20	How Far Will This Set Receive?.....	36
You Can Suppress That Interference.....	24	<b>NOVEMBER, 1924</b>	
How to Charge Your Storage B's.....	34	Our Most Successful Hook-Up.....	8
Answers to Questions on the Super-Heterodyne.....	36	Now's the Time to Overhaul.....	12
More About the "Levin Singletrol".....	41	How the Harkness Reflex Can Be Changed to the New Harkness Counterflex.....	14
<b>MAY, 1924</b>		Inverse Duplexing the Pfantstiehl System.....	18
The Story of Reflex and Radio Frequency.....	9	How Much of a Nuisance Are You?.....	25
The Aircore Super-Heterodyne.....	11	<b>DECEMBER, 1924</b>	
A Raw Amateur's Experiences With the Super-Heterodyne.....	18	Flewelling's New Circuit.....	11
A Favorite Circuit Simplified (Goodreau Circuit).....	24	The Two-Tube Harkness Counterflex.....	16
<b>JUNE, 1924</b>		3XP-Style Wire-Ups, Harkness Counterflex.....	18
Simple Hook-Up for Testing Tubes.....	6	Reflexing the Oscillating Set.....	21
Harkness Tells About His Reflex.....	9	A Favorite Circuit Simplified.....	28
The New Grimes 3XP Inverse-Duplex.....	12	Further Notes on the Inverse Duplex Neurodyne.....	54
Re-Radiating Receivers.....	16		
"Factory" Refinements in Home-Built Sets.....	17		
How to Become a DX Sharpshooter.....	19		
A Novel Loop Tuner.....	25		
<b>JULY, 1924</b>			
Harkness Writes About Self-Oscillation.....	13		
Trouble Shooting in the Grimes 3XP.....	15		

**THE RADIO KINDERGARTEN SERIES**—The above issues contain eight lessons on the fundamentals of radio. These lessons are written in simple language and are designed to acquaint the beginner in radio with the leading phases of radio reception.

**BROADCASTING STATIONS**—The following Stations were described and illustrated in the issues listed above: WBAP, WDAR, WJAX, WJAZ, WCB, WGN, WLS, WLAG, KFNF, WFAF, WTAM, KSAC, WEEL, WTAT.

The form below is for your convenience in ordering.

**RADIO IN THE HOME,**  
 608 Chestnut St., Phila., Pa.

Date .....

Enclosed find \$1.00 for which please send me the 11 consecutive issues of *RADIO IN THE HOME*, from February, 1924, to December, 1924, inclusive.

Name..... Street .....

City and State.....



Fig. 5; or if you contemplated building a three-tube Counterflex, go right ahead. The Fig. 3 circuit is by no means obsolete.

If any of the modifications given here, or in later articles for the benefit of experimenters, appeal to you, you will find that you can very easily change your set to use these modifications. Next month I will show you how to use the system of Fig. 5 with the three-tube circuit of Fig. 3.

Fig. 6 is the same circuit as Fig. 5. It is included to show experimenters the value of the fixed condensers, the arrangement of the binding posts and telephonic jack and the connections to the audio-frequency transformer.

Fig. 7 shows the same circuit with an extra stage of audio-frequency amplification. This, of course, is the most practical circuit to use. The audibility is increased so that a loud-speaker can be used and good volume obtained.

I shall be very glad to receive reports from readers who experiment with these circuits.

(To be continued next month)

### Those Short Waves

(Continued From Page 7)

shorter waves, use multiple reception to obtain better quality, and thus be able to rebroadcast the signal on the regular broadcasting waves. This is now done quite often, in particular by the Westinghouse Company, through their Station KDKA, at Pittsburgh.

Another point in question concerning the use of short-wave transmission is the common belief that the short waves travel as well by day as by night.

Very unfortunately, indeed, this is not so. It has been found that waves in the range of 20 to 30 meters reach out much better by day than by night; exactly opposite to those in the usual broadcast range of from 225 to 600 meters. Again waves of from 30 to 50 or 60 meters are apt to prefer the time from noon to midnight for long distances. There does not seem to be a happy medium that will travel as well by day as by night, although the field around 60 meters sometimes shows a little promise in this direction.

If we consider the field of waves shorter than 15 to 20 meters, we begin to enter the questionable; and for the waves of shorter than one meter in length it can only be said that here lies the Great Unknown with all its mysteries, thrills, and, if there be any, promises.

As to the question when broadcasting will be done on the short waves instead of those in use at present, let me remind you that this can probably only be done through congressional action or some other such action. This it is not likely to happen tomorrow afternoon. Again it is well to remember that there are now millions of dollars invested in broadcasting transmitters that would be useless for short-wave work. Also there is so much to be learned about the use of short waves that there are probably not enough engineering data available to assure success if the change were made to the short waves.

If any such change is made, it will come in the natural course of events after long continued work on the part of radio engineers. Like every other industry and art, radio progresses only in proportion to the time and energy devoted to it. On the other hand, the Westinghouse short-wave transmitter broadcasts regularly and simultaneously with the regular KDKA transmitter and has been heard in all parts of the world. Regular broadcasting on the short

waves is therefore happening at the present time, as you can see.

This brings us to the question often asked as to what can be heard in the short-wave range. It is, of course, not easy to answer this question because of the constantly changing conditions, due to the fact that all of the work that is being done at present is more or less of an experimental nature. One can be assured, however, that no matter where he lives the chances are that he will be able to hear KDKA. The author's station, 9XBG, has also been reported from practically the entire United States, although broadcasting from this station is necessarily of an infrequent nature. Stations in France and England have been heard in the Middle West, so that while there are but few stations broadcasting by means of short waves, their ability to cover greater distances often means the thrill of hearing a foreign station.

To return now for a moment to the question as to the greater distances possible with short-wave transmission. The amateur radio operator with his transmitter has been responsible for the importance that short waves are assuming in the field. Too, he is the one who has been able to point out by actual demonstration the enormous distances that it is possible to attain by their use.

This brings us to another reason for this article when I mention that so far we have been considering the use of short waves for radiophone work. The amateur has done but little phone work in the short-wave field; in fact, is not allowed to by his Government license, and there is a vast difference between the transmission of code and phone. Code, you understand, consists of nothing but dot and dash signals and, roughly speaking, has but one tone. Quality of tone does not count for much; it is the ability to get a signal through regardless, if necessary, of quality.

This rather more simple operation naturally aids the transmitter considerably. On the contrary, radiophone transmission requires the transmission of practically all of the notes or frequencies in the audible range, the full scale of the piano, various musical instruments, etc., and this, it can be seen, is a tremendously more difficult problem, because quality transmission becomes paramount in importance and it may be necessary to limit the distance of transmission for the sake of securing quality of reception.

So far in our discussion of the subject we have not been extremely kind to short-wave transmission, but we are also able to show very good reasons why their use may quite likely be universal at some future time.

As I have said, the amateur has shown the possibilities of distance transmission. He has done this so well that many times he has sent signals half around the world with only about as much power in his transmitter as is used to light one's reading lamp—surely a marvelous achievement and one that begins to make us wonder what is to come in short-wave power transmission.

We can also add one or two more advantages to the credit of short waves. One, for instance, the fact that it becomes possible to use extremely small antennae. The brass curtain rod, two or three feet long, above your window, would serve as a very excellent antenna for the transmission or reception of waves in the neighborhood of four or five meters long. Proportionately then, it should be possible to carry in our pockets, without folding, a perfectly good antenna for waves under one meter in length! Miniature transmitters, receivers and antennae, operating with small power expenditure,

## Better Contact

An easy way to get distant stations clearly

It's important at all times—but doubly important in summer, when static is apt to be troublesome—to have clean, perfect contact between tubes and sockets. If you don't, the almost unnoticeable films of corrosion act as barriers for the delicate currents; magnified, they cause annoying noises.

### "It's the contact that counts"

Na-Ald Sockets remove those barriers. The exclusive side-scraping contacts (not just side pressure) of Na-Ald DeLuxe Sockets cut the corrosion from the sides of tube terminals. A turn or two of the tube—and the tube terminals are clean.

The Alden-processed Bakelite conserves all the current energy. Laboratory tests proved Na-Ald Sockets most efficient in low loss and low capacity.

Na-Ald Adapter No. 429 and Na-Ald Socket No. 499 are especially made for use with UV-199 and C-299, and No. 411 for WD-11 tubes, all of which are used with dry batteries. They are a big aid to the highest tube efficiency.

Use Na-Ald Sockets not only in the set you build, but also install them in the set you buy. At all dealers.

Mail coupon for free booklet, "What to Build," giving tested, selected circuits.

ALDEN MANUFACTURING COMPANY  
Also makers of the famous Na-Ald Dials  
Dept. J-7, Springfield, Mass.



Na-Ald DeLuxe Socket No. 400, 75c



Na-Ald Small Space Socket No. 401, 35c



Na-Ald Socket No. 411, 75c



Na-Ald Socket No. 499, 50c



Na-Ald Adapter No. 429, 75c



Alden Manufacturing Co.,  
Dept. J-7, Springfield, Mass.,  
Send me free booklet, "What to Build"

Name .....

Address .....

## "Last night we heard the sweetest voice"



Few boast of having heard a powerful voice. Radio has grown up. It is now something to listen to, not to marvel at. We are now in the cycle of TONE!

The other day a man said he was just realizing that he had a hundred dollars' worth of set and a dollar's worth of horn! His next move is to balance up his set with a good speaker.

The BRISTOL has all the volume you will ever want, but its fine point is TONE. It is good to listen to. The notes come in in tune. You receive a wealth of music from which the cream of tone has not been skimmed.

For \$20, \$25 or \$30 you can get a Bristol Speaker, and there are others for less. Ask your dealer to send one out to the house. And let us send you folder No. 3022-Q; it tells why the Bristol is the horn of tone.

## BRISTOL AUDIOPHONE Loud Speaker

THE BRISTOL COMPANY, WATERBURY, CONN.



## Fit for a King

Britain's greatest engineers, in designing receiving equipment for His Majesty, KING GEORGE V, chose Resistance Coupled Amplification. None other would do.

### The DAVEN RESISTANCE COUPLED SUPER AMPLIFIER

will give to your favorite tuner that finesse in quality amplification desired for the Chambers of Buckingham Palace. With Resistance Coupling, overtones and undertones are amplified alike, therefore, distortionless. The most delicate shadings in musical composition, either with instruments or the voice, are reproduced with a faithfulness not obtainable with any other method of amplification. It costs less to install than other methods of amplification and adds greatly to the life of your "B" Batteries.



#### DAVEN RESISTANCE COUPLED KITS

These kits are put up in three or four stages and bring perfection of amplification to those who would rather build than buy a completely assembled Resistance Coupled Amplifier. Secure from your Dealer the "RESISTOR MANUAL," our complete handbook on Resistance Coupled Amplification. Price 25c. Postpaid 35c.

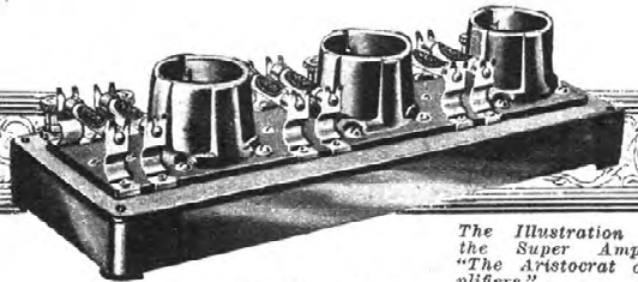

The illustration shows the Super Amplifier—"The Aristocrat of Amplifiers."

The Sine of Merit

**DAVEN RADIO CORPORATION**

"Resistor Specialist."  
NEWARK, N. J.

yet able to communicate around the world, is something for us to dream about.

I have referred throughout this article to waves in terms of their length only because this has been the popular way of thinking of them. It is far better, though, to think of the waves in terms of their frequency rather than their length because it in a way means more.

For example, the length of the wave does not help us directly, so far as the much-discussed subject of selectivity is concerned. Selectivity is one of the factors that has determined for us how much radio we can use without destructive interference, and selectivity is primarily dependent upon the frequency of the wave.

To illustrate more clearly, perhaps, what is meant here, consider the wave lengths used in broadcasting—those from 200 to 600 meters long. A 200-meter wave has a frequency of 1,500,000 cycles, that is, it reverses its direction that many times each second. A 600-meter wave has a frequency of 500,000 cycles. Now, in general radio-phone work, with a receiver of the better type, two transmitting stations should be separated by a frequency difference of at least 10,000 cycles in order that they shall not interfere with each other. Between the 600-meter wave of 500,000 cycles and the 200-meter wave of 1,500,000 cycles there is a total difference of 1,000,000 cycles, which means that only 100 stations might operate within this band and be free from interference.

It will be seen from the above that the shorter the wave the greater its frequency. A wave one meter long has a frequency of 300,000,000 cycles per second and a wave of 5 meters length has a frequency of 60,000,000 cycles, a difference of 240,000,000 cycles. Dividing this by our necessary separation figures of 10,000 cycles we find that we could operate 24,000 stations in this band without interference. If broadcasting ever is done on the waves under 5 meters in length, it is conceivable that one might have to take about half a day off in order to find the local station unless more general use is made of wave meters.

H. M. N. I am sure would be glad to include in an early issue of *Radio in the Home* an article on how to build a short wave—or, for that matter, a universal range-receiver if my readers desire.

*NOTE.—Sure I will. All that our readers have to do is to let us know that they want such an article and the necessary space will be allotted at once.*  
H. M. N.

### Now Women Demand Their Share of Programs

(Continued From Page 17)

of soap have been put. Use boiling water for all of the dishes except the silverware.

Wash glassware first, then silver, then cups and saucers, plates and serving dishes. As I said before, it is easier to wash the pots and pans during the preparation of the meals.

Glassware will be brighter if not much soap is used, though a little makes it brighter. Using the dish mop, first wash the glasses inside and out, rinse them and place them upside down, slightly tipped, in the drain basket, and then dry them. The silverware may be cleaned satisfactorily and quickly with the mop, and this method keeps the hands out of the water.

Have you a drain basket? It is such a time saver and does away to a large extent with the insanitary dish towel. After washing the dishes, stack them in the racks and scald

# CARTER

## Radio Receptacle Jack for Wall Mounting

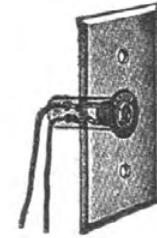

No. 302

\$1

Pat. 1-30-23

For use in homes, etc., for aerial and ground, battery and loud-speaker connection.

Fits all standard Radio plugs.

The jack can be mounted flush on the wall or baseboard, or in regular outlet box.

Extends 1 1/8" back of plate and is completely encased in shell.

The jack is provided with terminal screws—connections can be made without solder.

Any dealer can supply



In Canada—

Carter Radio Co., Ltd., Toronto



# HARKNESS

## Counterflex and Reflex Kits



#### MODEL "C"

The 3-TUBE CIRCUIT—Actually better than the average 5-tube.

List Price: United States ..\$39.50  
Canada .....\$48.00

#### MODEL "B"

The ORIGINAL HARKNESS REFLEX Two Tubes and Crystal

List Price: United States ..\$35.00  
Canada .....\$42.50

Both kits include all necessary parts and instructions. Reflex sets are the Best Summer Sellers.

Jobbers and Dealers—Write

**KENNETH HARKNESS RADIO CORP.**

727 Frelinghuysen Ave,  
Newark, N. J.

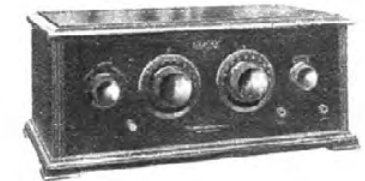

### Make Money Building This Set for Friends

Here is a 4-tube set with 5-tube volume and a wonderfully sweet tone. It is not reflexed, but employs the circuit (with improvements) which made the Greene Concert Selector such a favorite in the East.

The secret is the L+K Variable Clarifying Selector and the VT25 Variotransformer, so widely praised by radio authorities. The Selector is a patented aerial tuner that gives needle-point selectivity. The VT25 is a variable transformer, operating without a condenser, that gives the amplification of two ordinary fixed R. F. transformers. Both will improve any standard hook-up.

We'll supply all the parts and charts and free expert advice to build this excellent set. Get just one set working in your neighborhood and you'll soon be good and busy on very profitable work. Write for Free diagram spread and particulars.

Address

**The Langbein-Kaufman Radio Company**

511 Chapel St., Dept. R.,  
New Haven, Conn.

